

# Stromlauf- und Heizungspläne DHH Wendelken



c				Druck:	27/05/2020	E-Verteilung		Hausverteilung		.-1		
b			Erstellt:	29/10/2017								
a			Gez.	Wendelken								
	MODIFICATION	Datum	Name	Gepr.	T.Wendelken			Deckblatt	2006	EIB	Blatt : 1	

# Funktionsübersicht

=50	Übersichten
=100	Einspeisung & Messung
=110	Fehlerstromschutzschalter (RCD) & Bereichsicherungen
=130	24V DC Versorgung
=150	KNX Versorgung & Übersicht
=155	LOGO! Steuerung
=170	Klingelanlage
=180	DSL, Telefon & Ethernet
=190	Sat-Anlage
=200	Hauswirtschaftsraum
=210	Küche
=220	WC
=230	Arbeitszimmer
=240	Flur EG
=250	Wohn- & Esszimmer
=260	Heizkreisverteiler EG
=270	Rolläden EG
=300	Flur OG
=310	Bad
=320	Schlafzimmer
=330	Zimmer klein
=340	Zimmer groß
=350	Dachboden
=360	Heizkreisverteiler OG
=370	Rolläden OG
=400	Beleuchtung & Steckdosen Haus Außenbereich
=410	-Option- Garten
=430	Beleuchtung & Steckdosen Schuppen & Carport
=500	Heizung
=600	Photovoltaikanlage

c			Druck:	27/05/2020
b			Erstellt:	03/02/2018
a			Gez.	Wendelken
	MODIFICATION	Datum	Name	Gepr.
				T.Wendelken

E-Verteilung



Hausverteilung		.-1	=50	1
Übersichten	2006	EIB	Blatt : 2	2

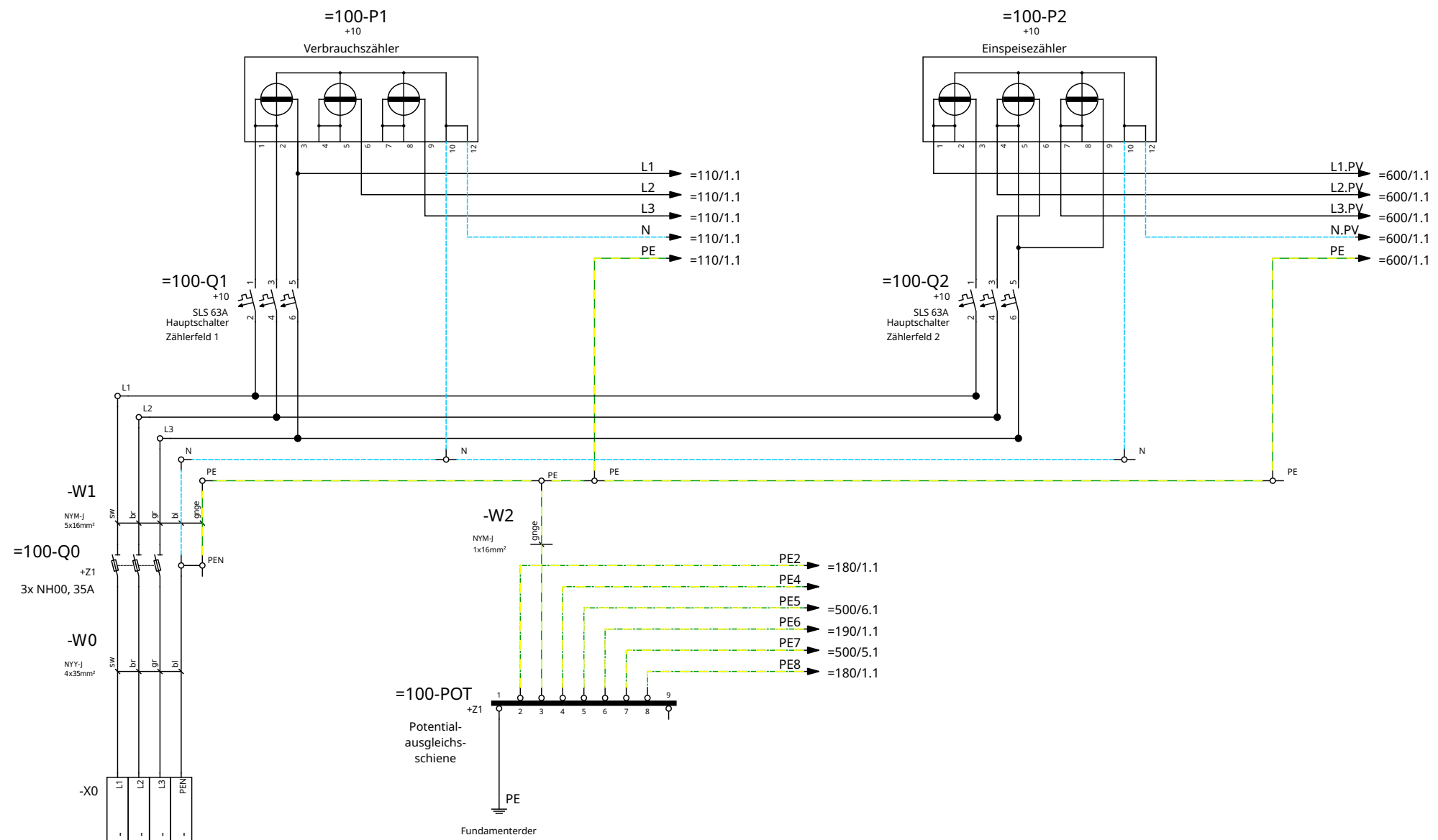

c			Druck:	27/05/2020
b			Erstellt:	26/10/2017
a			Gez.	Wendelken
	MODIFICATION	Datum	Name	Gepr.
				T.Wendelken

E-Verteilung



Wendelken

Hausverteilung		.-1	=100	1
Einspeisung	2006	EIB	Blatt : 3	3

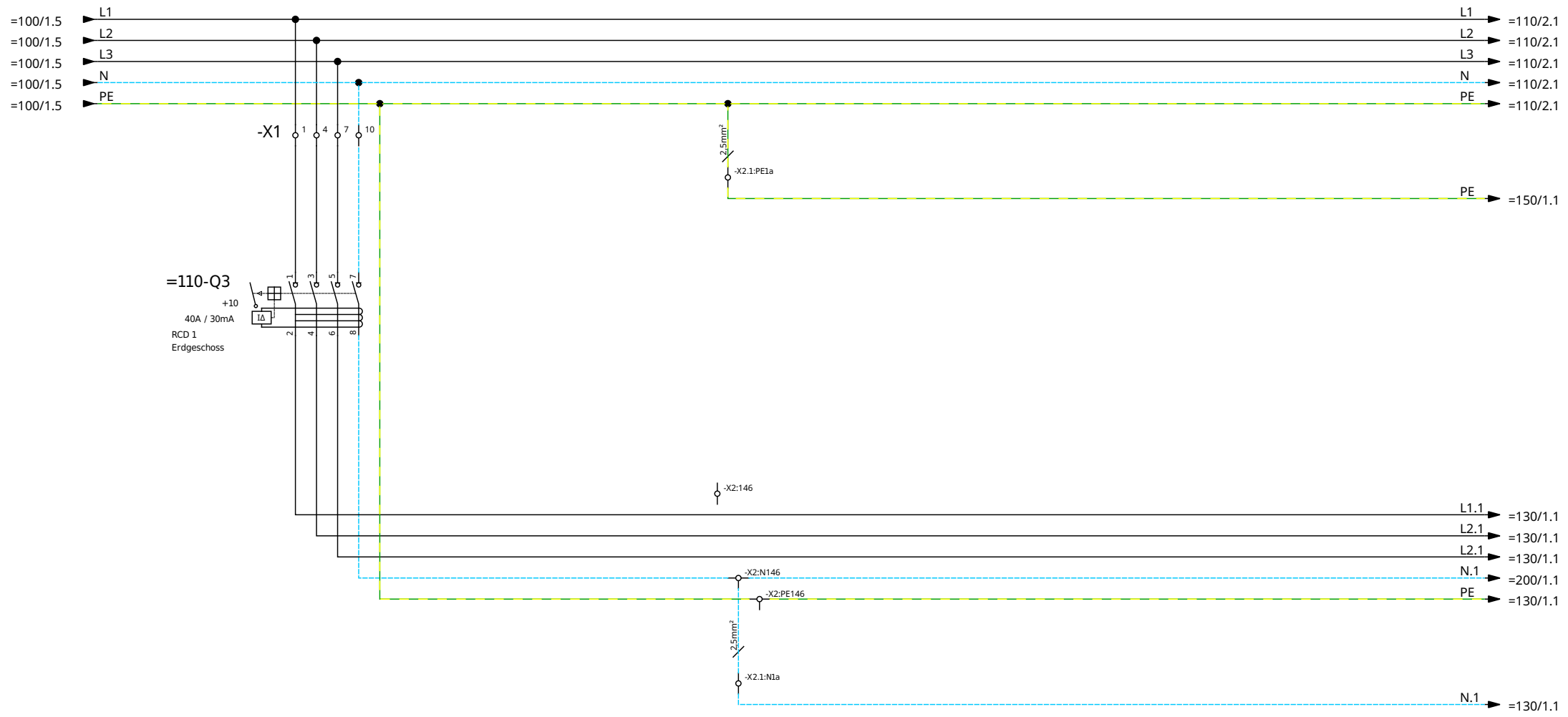

Alle Leitungen ohne Querschnittsangabe sind 16mm²

c			Druck:	27/05/2020
b			Erstellt:	24/02/2017
a			Gez.	Wendelken
	MODIFICATION	Datum	Name	Gepr.
				T.Wendelken

E-Verteilung



Hausverteilung		.-1	=110	1
Fi-Kreis 1 / Erdgeschoss	2006	EIB	Blatt : 4	4

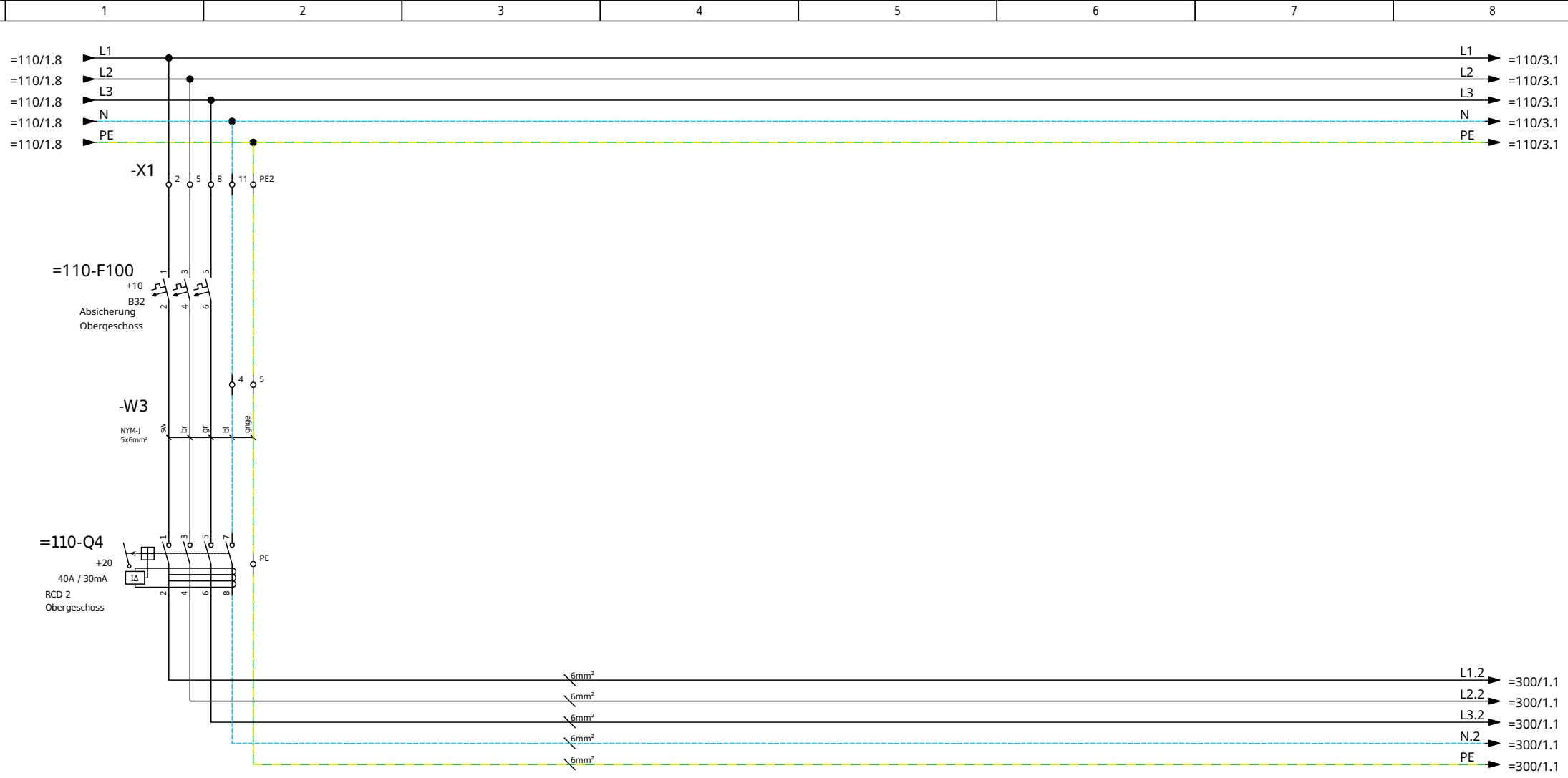

c				Druck:	27/05/2020
b				Erstellt:	31/01/2017
a				Gez.	Wendelken
	MODIFICATION	Datum	Name	Gepr.	T.Wendelken

E-Verteilung



Hausverteilung  
Fi-Kreis 2 / Obergeschoss

2006

.-1  
EIB

=110  
Blatt : 5

2  
5

Alle Leitungen ohne Querschnittsangabe sind 16mm²

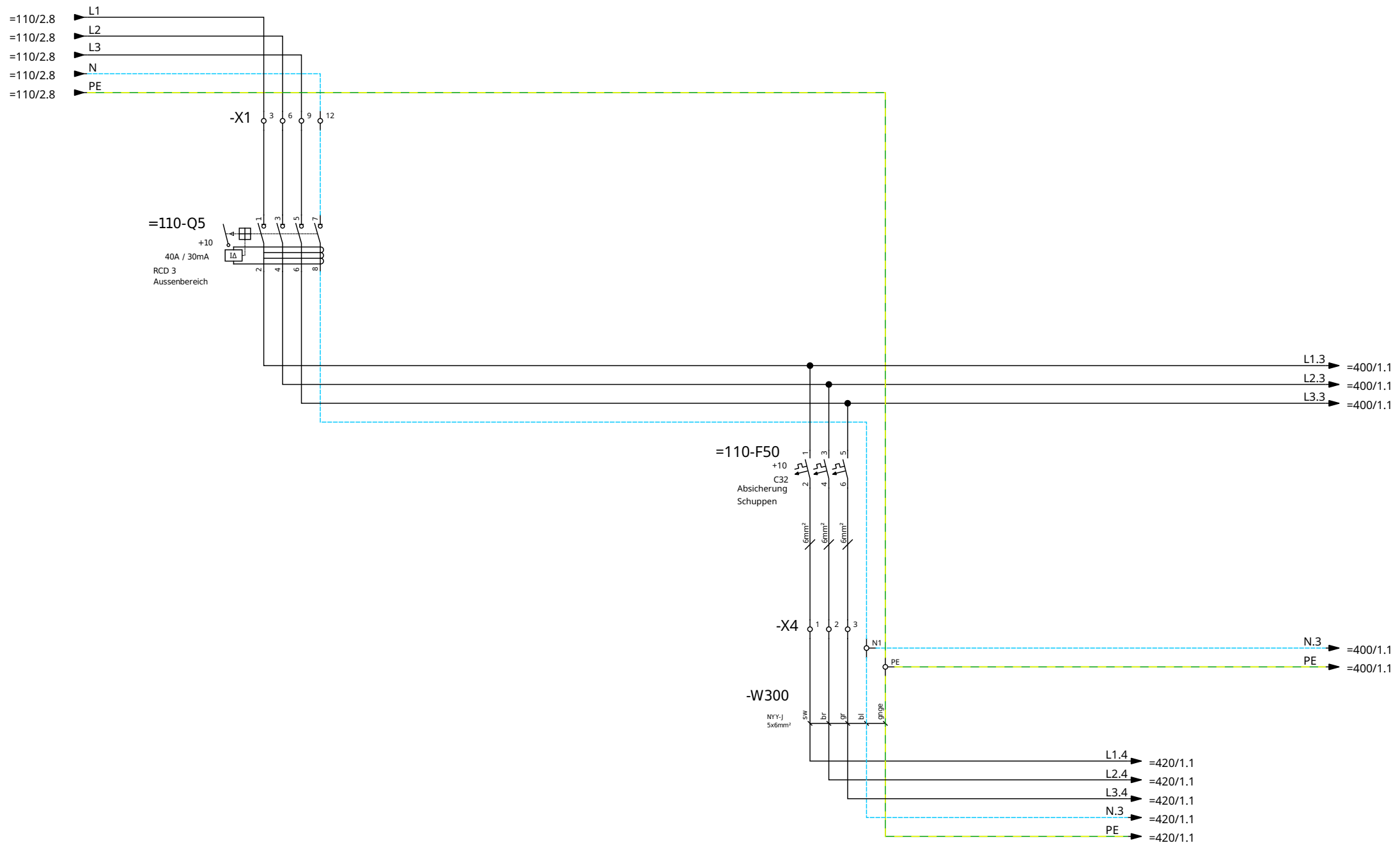

Alle Leitungen ohne Querschnittsangabe sind 16mm²

c			Druck:	27/05/2020
b			Erstellt:	24/02/2017
a			Gez.	Wendelken
	MODIFICATION	Datum	Name	Gepr.
				T.Wendelken

E-Verteilung



Hausverteilung  
Fi-Kreis 3 / Draußen

2006

.-1  
EIB

=110  
Blatt : 6

3  
6

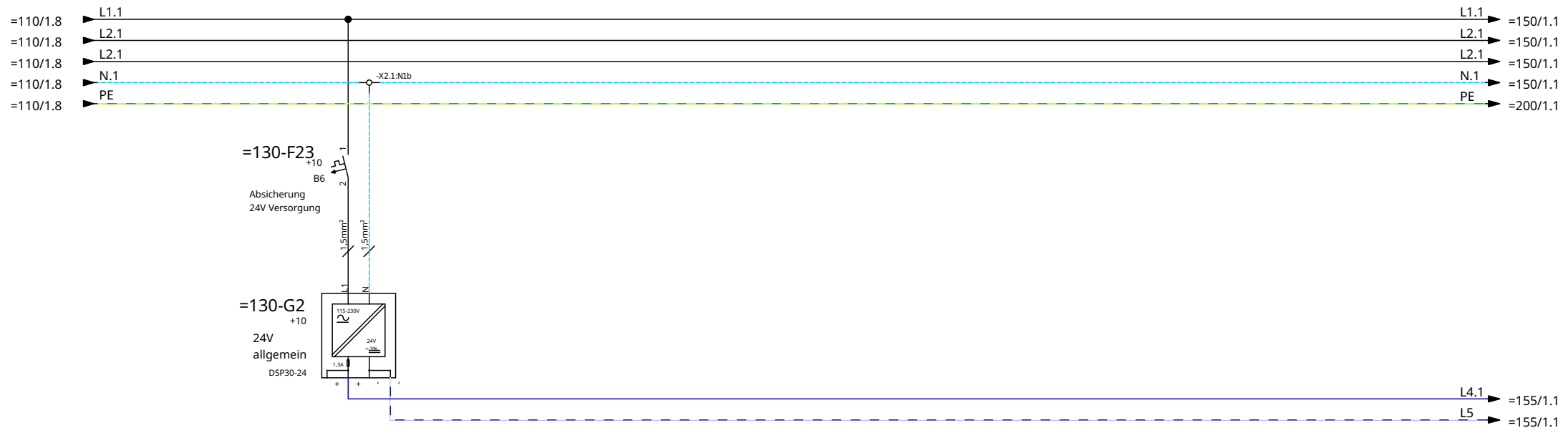

Alle Leitungen ohne Querschnittsangabe sind 0,75mm²

c			Druck:	27/05/2020
b			Erstellt:	06/04/2017
a			Gez.	Wendelken
	MODIFICATION	Datum	Gepr.	T.Wendelken

E-Verteilung



Hausverteilung  
24V Versorgung

2006

.-1  
EIB

=130  
Blatt : 7

1  
7

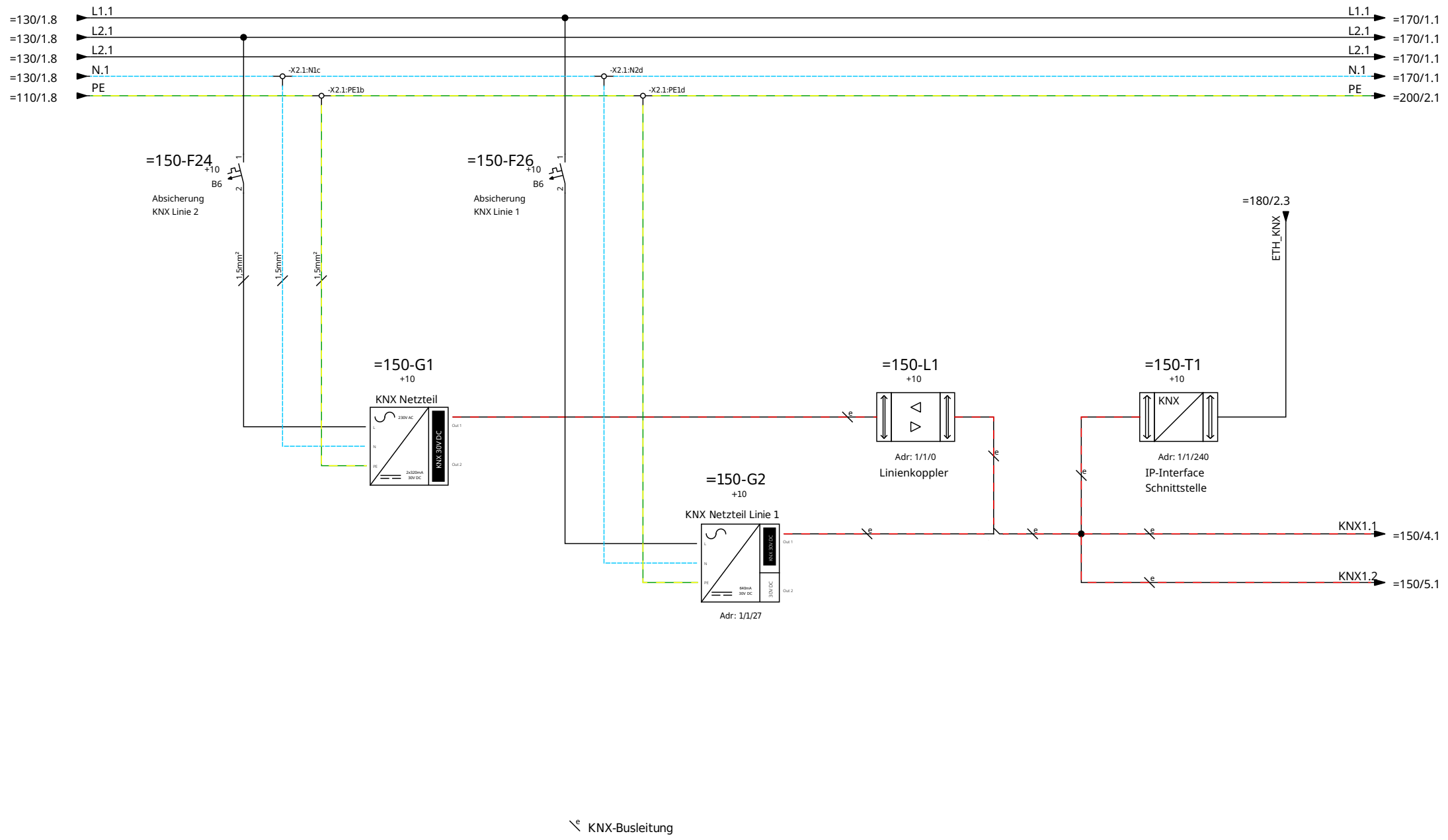

Alle Leitungen ohne Querschnittsangebe sind 1,5mm²

c			Druck:	27/05/2020
b			Erstellt:	06/04/2017
a			Gez.	Wendelken
	MODIFICATION	Datum	Name	Gepr.
				T.Wendelken

E-Verteilung

Wendelken

Hausverteilung	.-1	=150	1
KNX Versorgung	2006	EIB	Blatt : 8



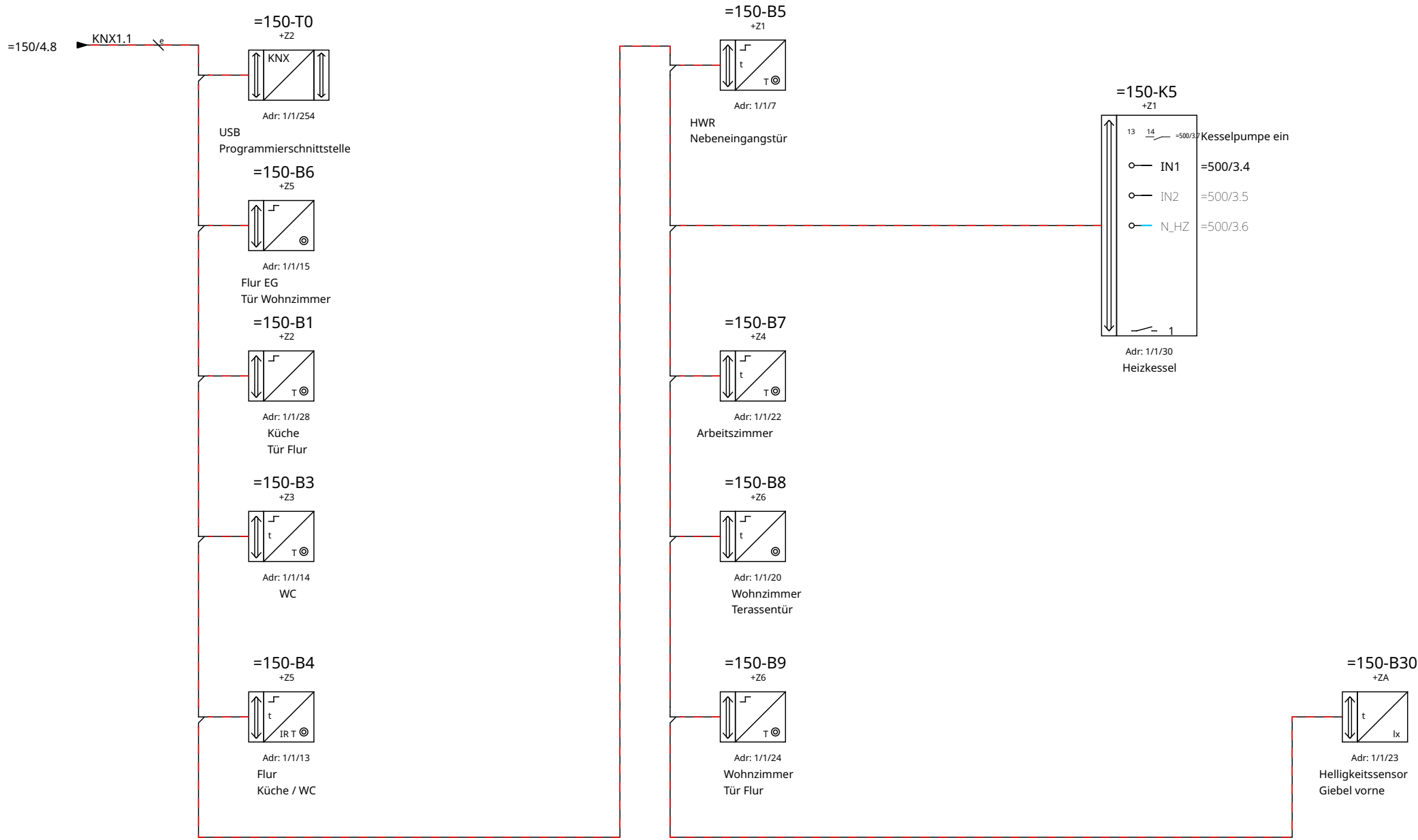

KNX-Busleitung

c			Druck:	27/05/2020
b			Erstellt:	08/10/2017
a			Gez.	Wendelken
	MODIFICATION	Datum	Name	Gepr.
				T.Wendelken

E-Verteilung

Wendelken

Hausverteilung		.-1	=150	2
KNX Sensoren EG	2006	EIB	Blatt : 9	9

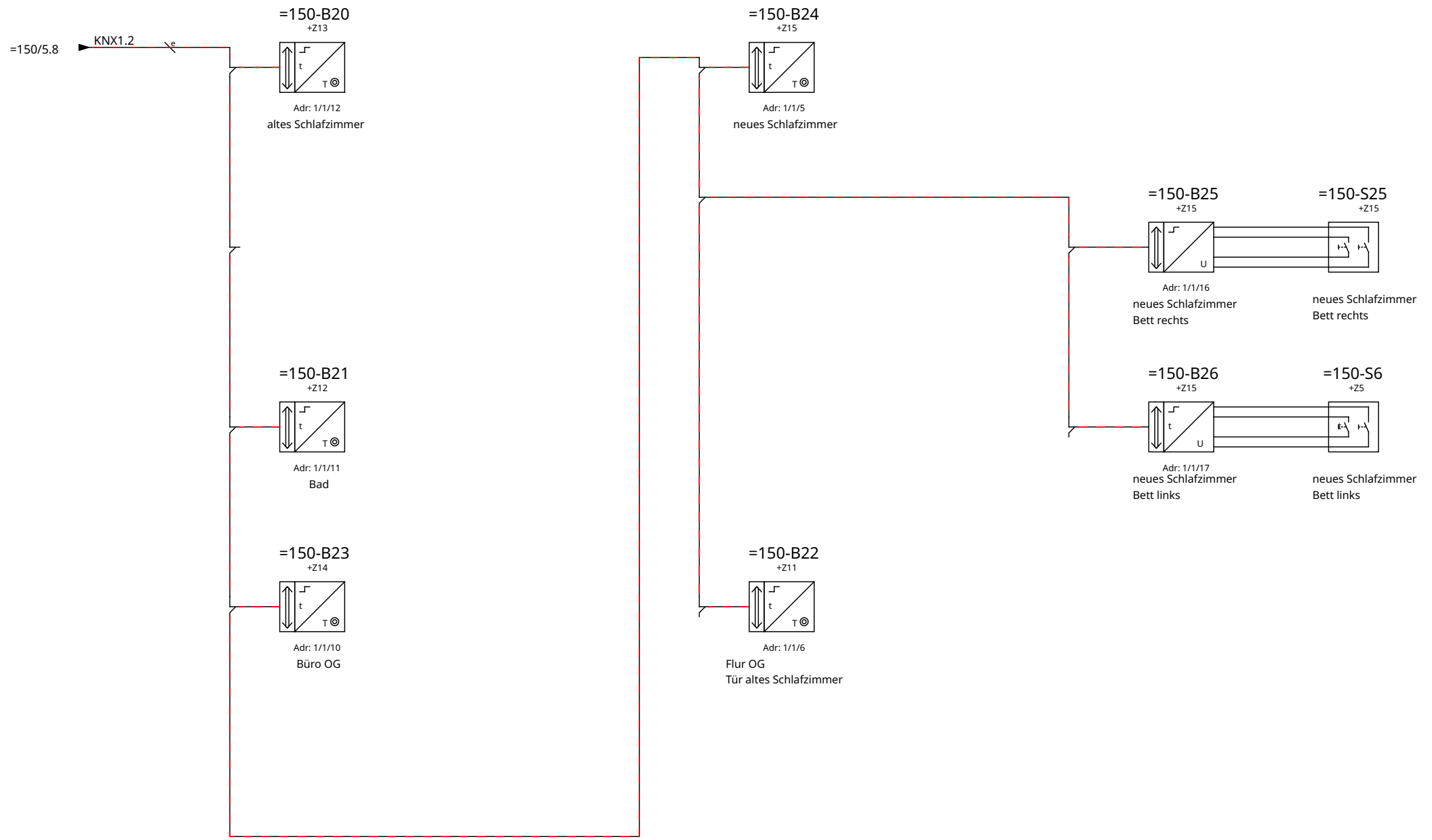

KNX-Busleitung

c			Druck:	27/05/2020
b			Erstellt:	28/01/2018
a			Gez.	Wendelken
	MODIFICATION	Datum	Name	Gepr.
				T.Wendelken

E-Verteilung



Hausverteilung  
KNX Sensoren OG

2006

.-1  
EIB

=150  
Blatt : 10

3  
10

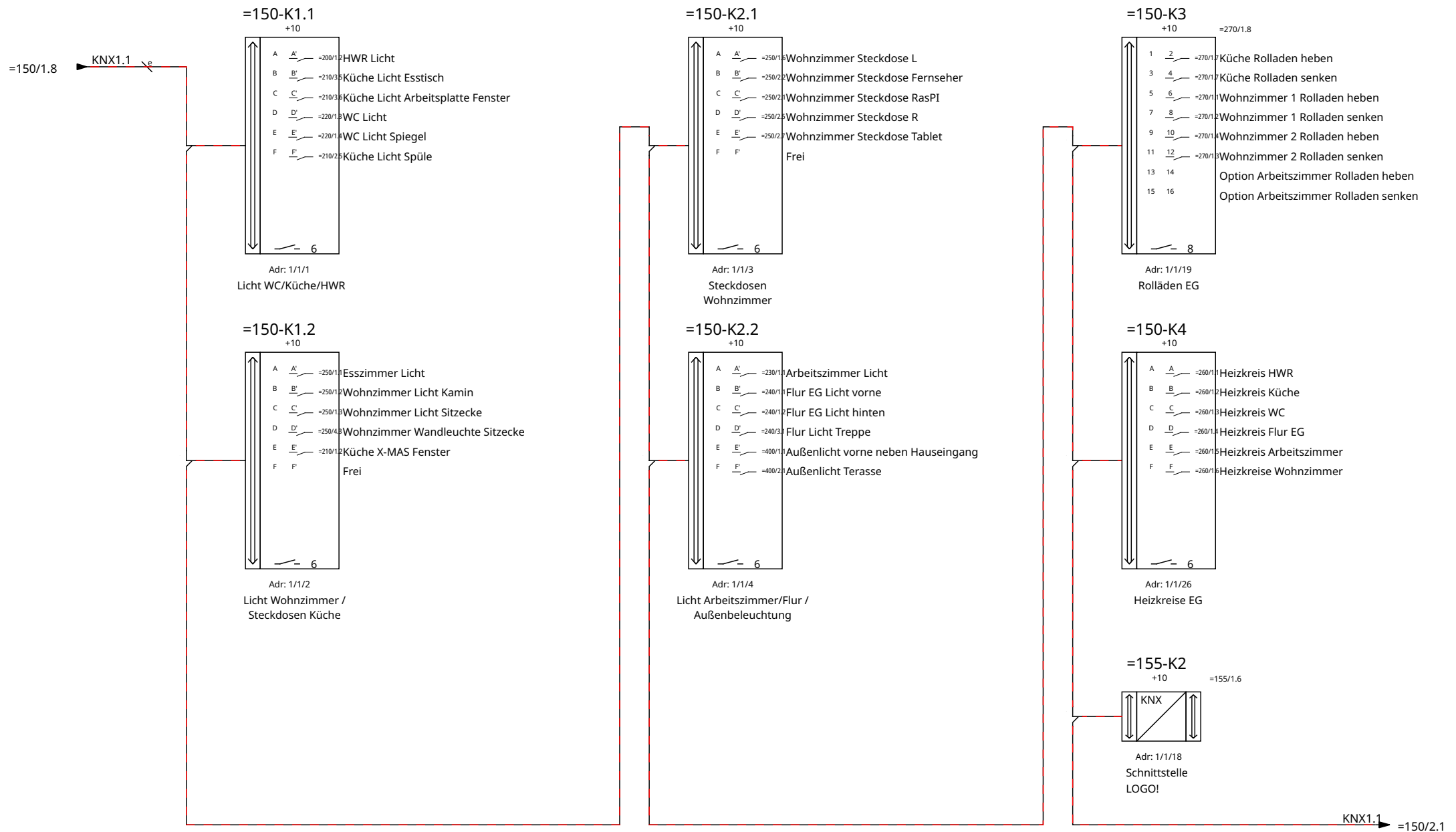

KNX-Busleitung

c			Druck:	27/05/2020
b			Erstellt:	16/01/2017
a			Gez.	Wendelken
	MODIFICATION	Datum	Name	Gepr.
				T.Wendelken

E-Verteilung



Hausverteilung

KNX Aktoren EG

2006

.-1

=150

EIB

Blatt : 11

4

11

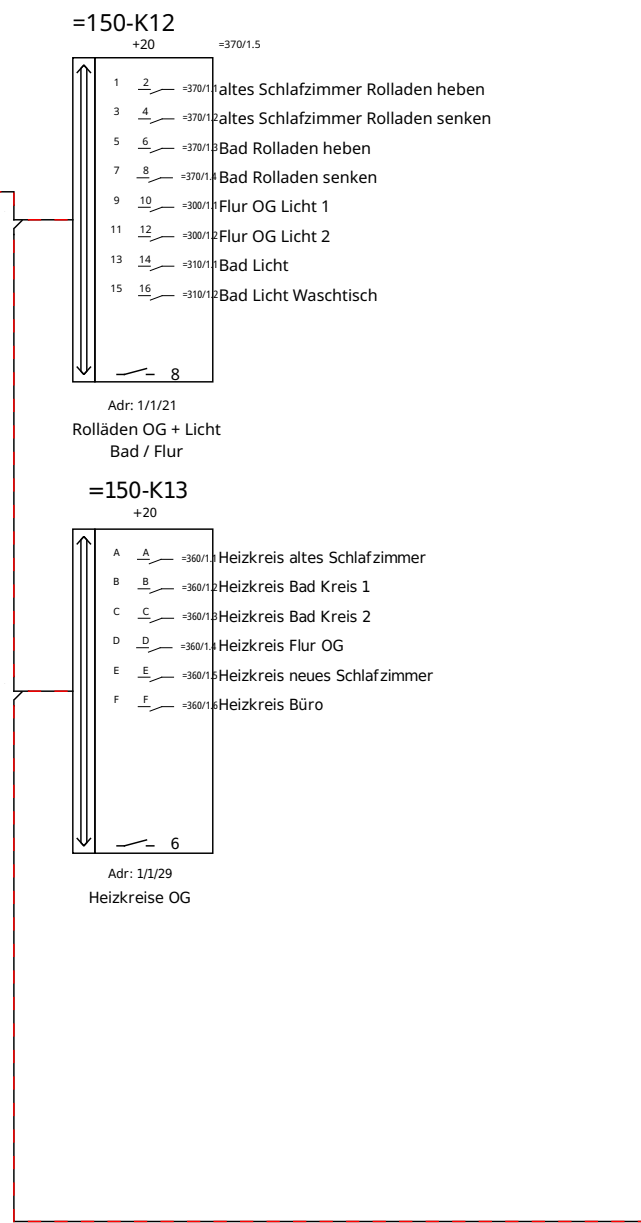
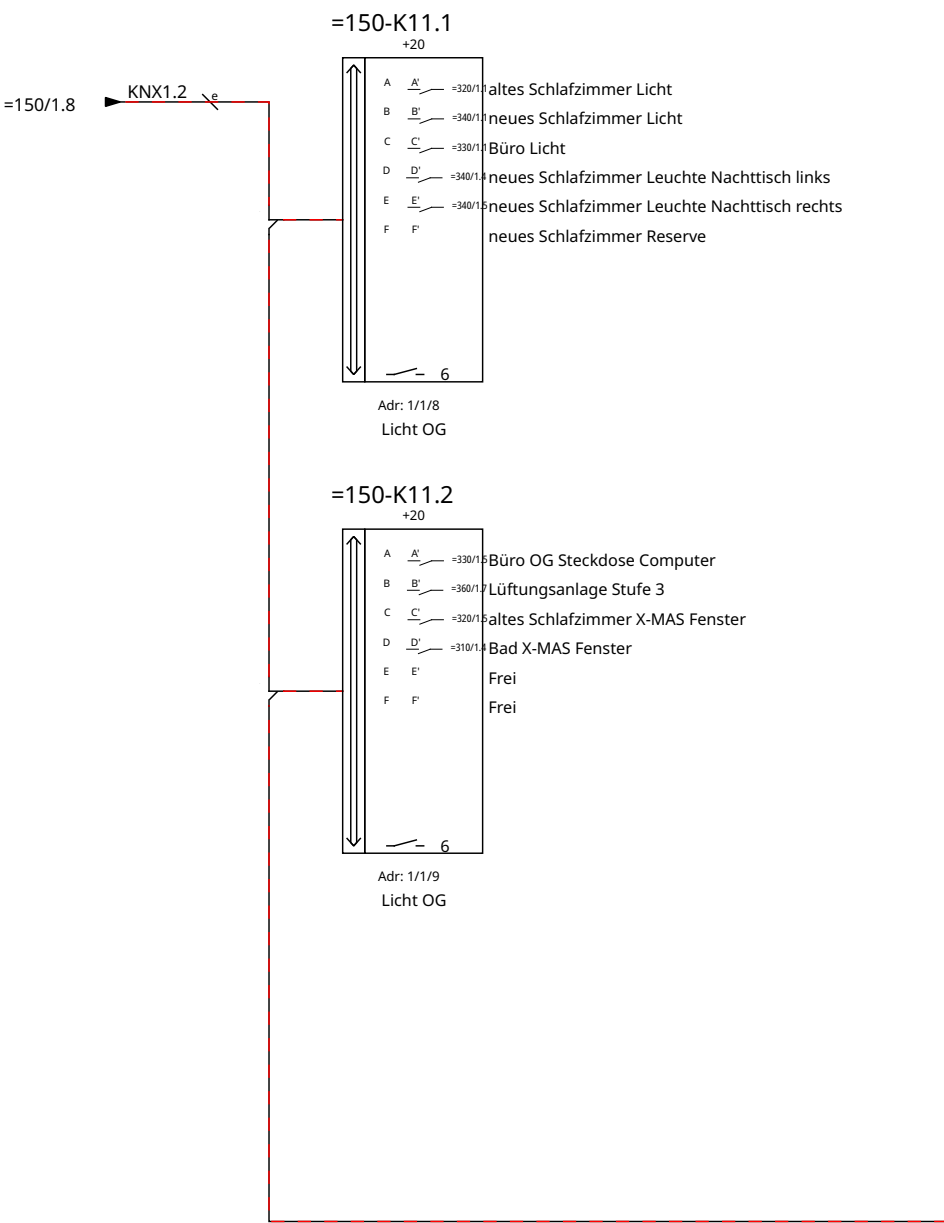

KNX1.2 → =150/3.1

↘ KNX-Busleitung

c			Druck:	27/05/2020
b			Erstellt:	25/10/2017
a			Gez.	Wendelken
	MODIFICATION	Datum	Name	Gepr.
				T.Wendelken

E-Verteilung

Wendelken

Hausverteilung	.-1	=150	5
KNX Aktoren OG	2006	EIB	Blatt : 12

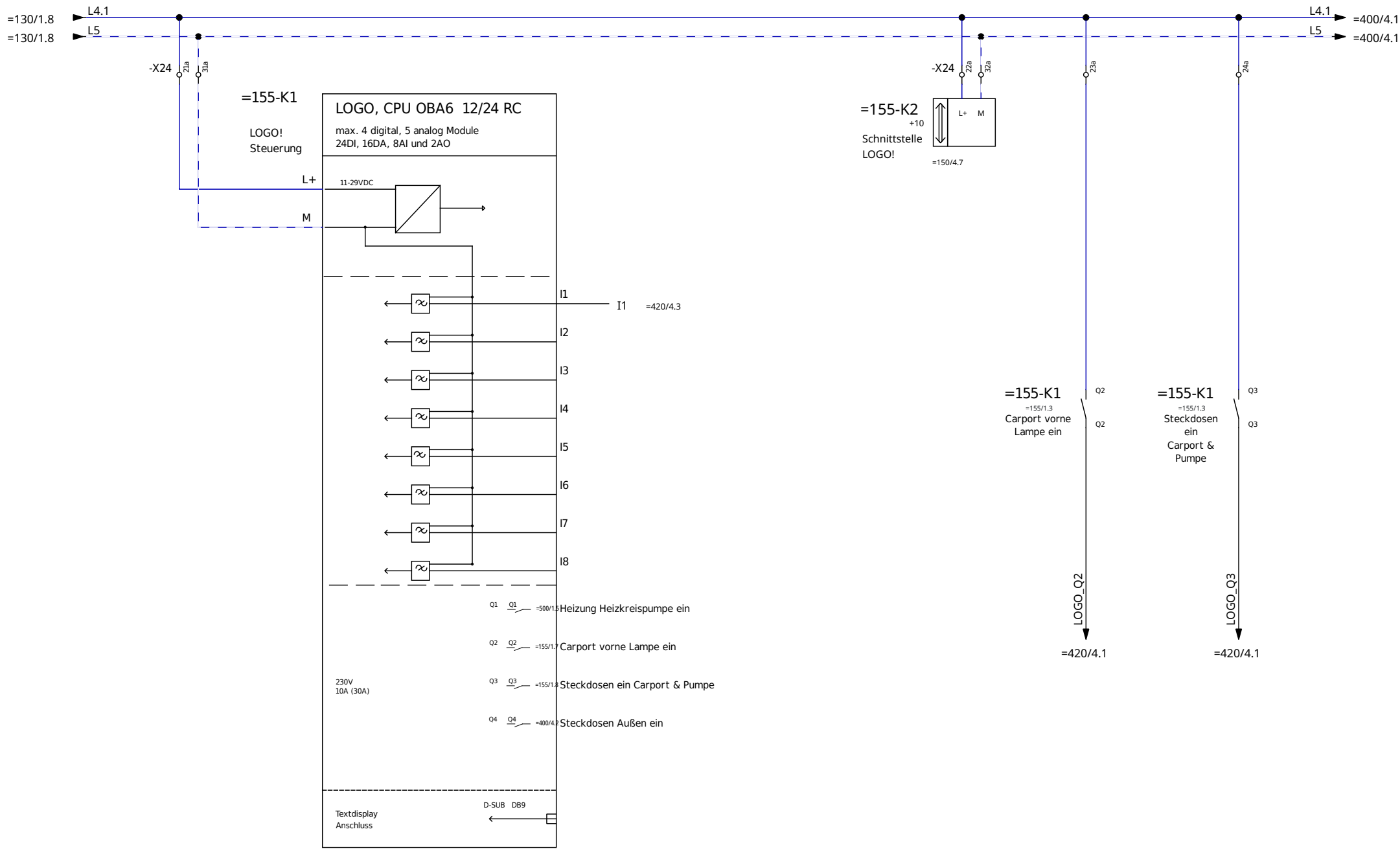

Alle Leitungen ohne Querschnittsangebe sind 0,75 mm<sup>2</sup>

c			Druck:	27/05/2020
b			Erstellt:	06/04/2017
a			Gez.	Wendelken
	MODIFICATION	Datum	Name	Gepr.
				T.Wendelken

E-Verteilung



Hausverteilung					
Logo! Steuerung	2006	.-1	EIB	=155	1
			Blatt : 13		13

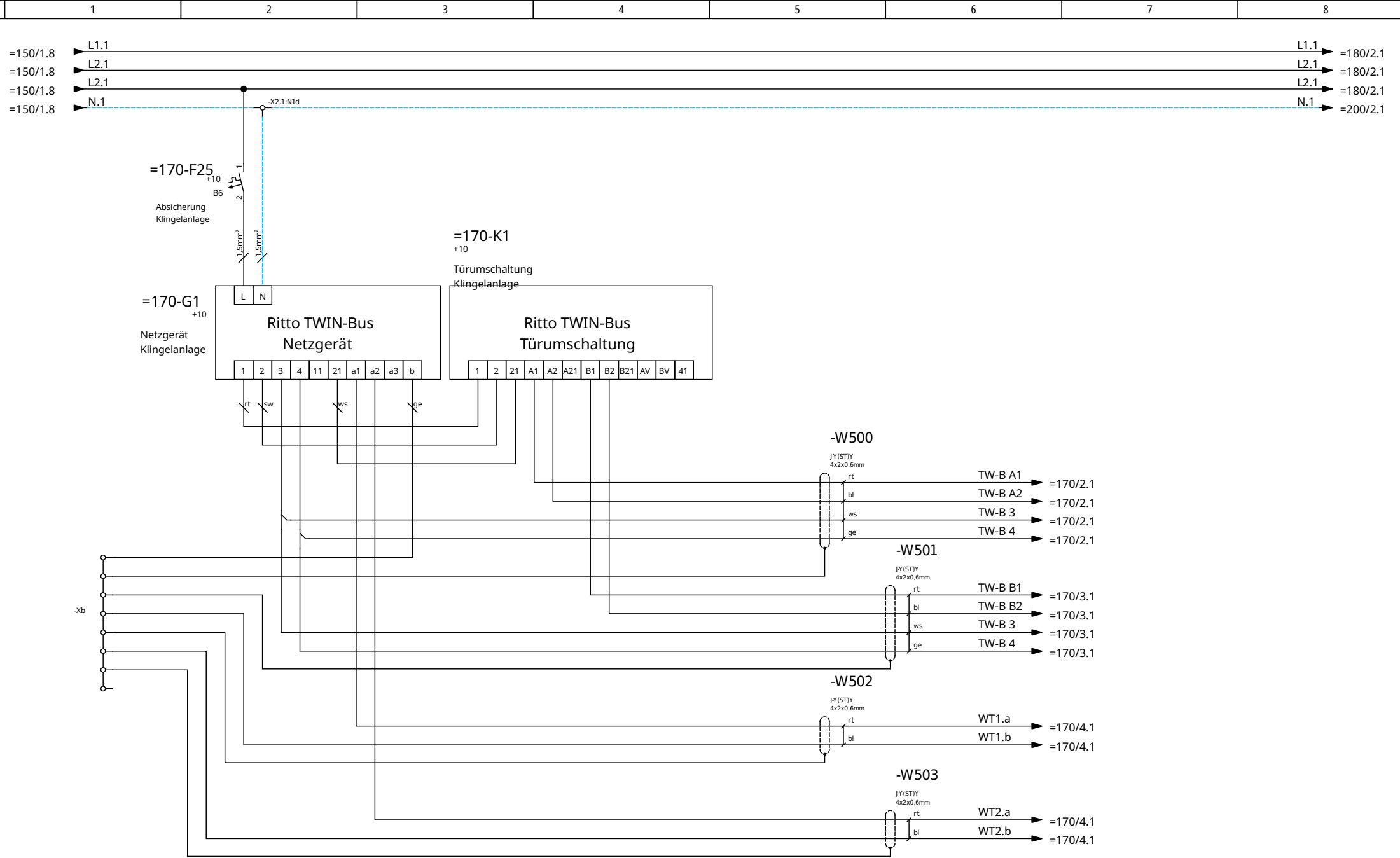

Alle Leitungen ohne Querschnittsangabe sind 1,5mm<sup>2</sup>

c			Druck:	27/05/2020
b			Erstellt:	28/01/2018
a			Gez.	Wendelken
	MODIFICATION	Datum	Name	Gepr.
				T.Wendelken

E-Verteilung



Hausverteilung  
Klingelanlage

2006

.-1  
EIB

=170  
Blatt : 14

1  
14

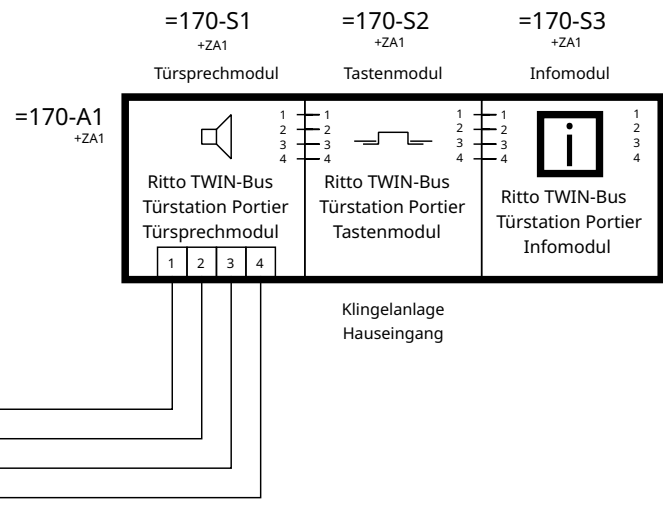

c				Druck:	27/05/2020
b				Erstellt:	28/01/2018
a				Gez.	Wendelken
	MODIFICATION	Datum	Name	Gepr.	T.Wendelken

E-Verteilung



Hausverteilung  
Klingelanlage

2006

.-1  
EIB

=170  
Blatt : 15

2  
15

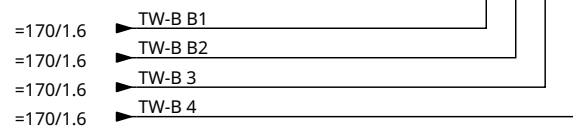
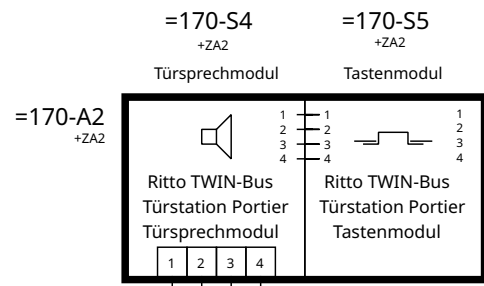

c			Druck:	27/05/2020
b			Erstellt:	28/01/2018
a			Gez.	Wendelken
	MODIFICATION	Datum	Name	Gepr.
				T.Wendelken

E-Verteilung



Hausverteilung  
Klingelanlage

2006

.-1  
EIB

=170  
Blatt : 16

3  
16



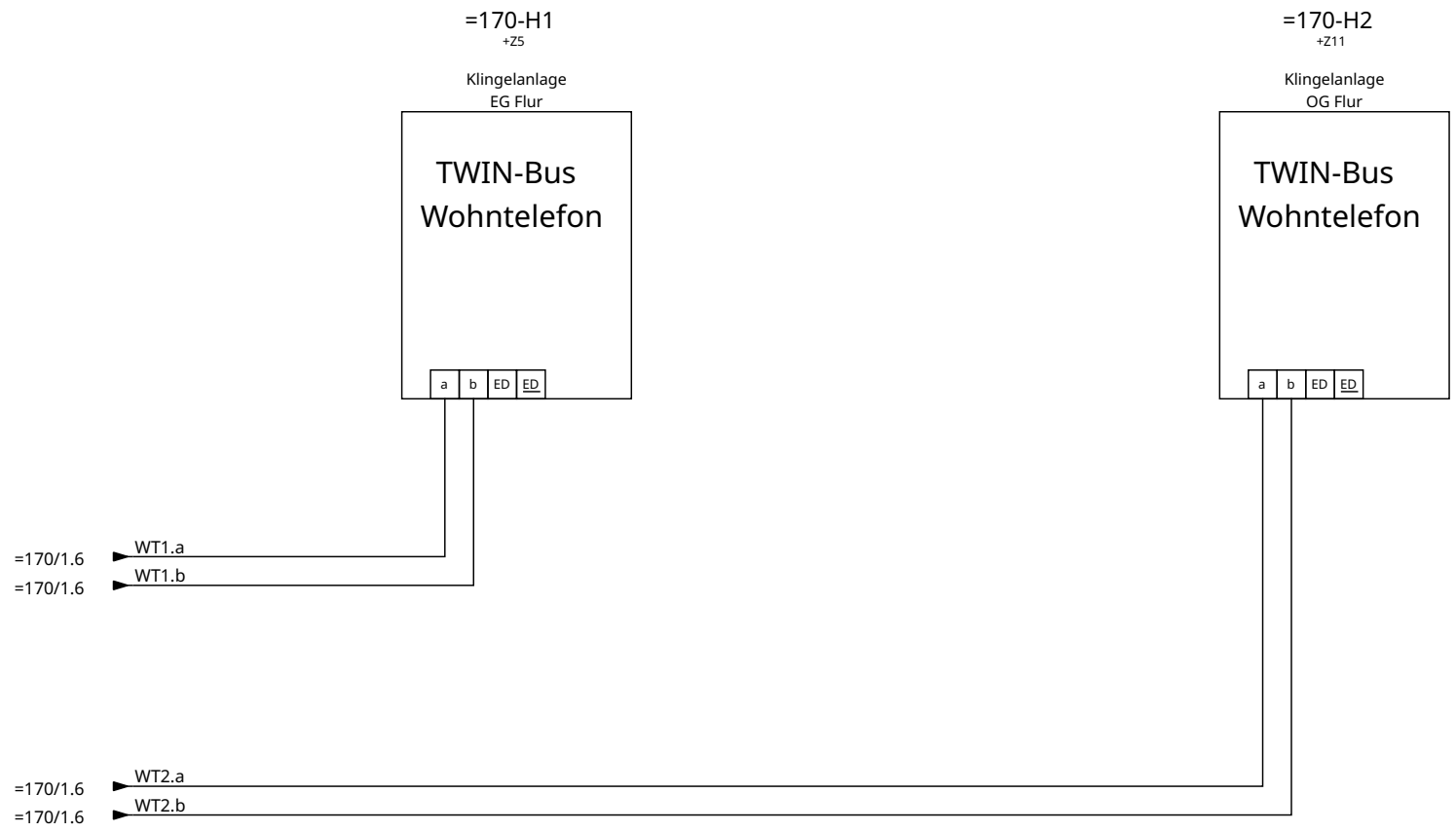

c				Druck:	27/05/2020
b				Erstellt:	28/01/2018
a				Gez.	Wendelken
	MODIFICATION	Datum	Name	Gepr.	T.Wendelken

E-Verteilung



Hausverteilung  
Klingelanlage

2006

.-1  
EIB

=170  
Blatt : 17

4  
17

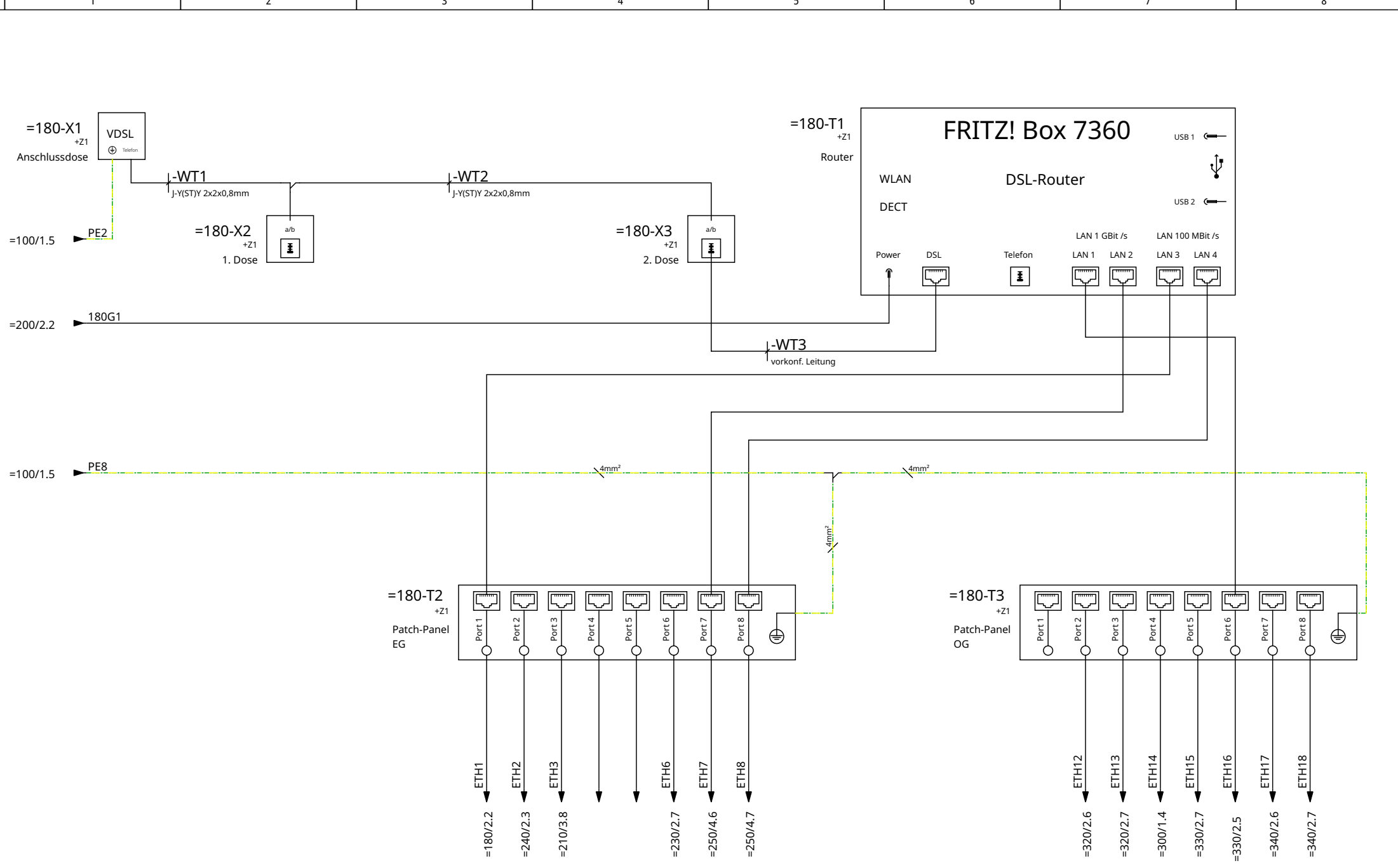

c			Druck:	27/05/2020
b			Erstellt:	28/10/2017
a			Gez.	Wendelken
	MODIFICATION	Datum	Name	Gepr.
				T.Wendelken

E-Verteilung	 Wendelken	Hausverteilung	.-1	=180	1
		Ethernet			

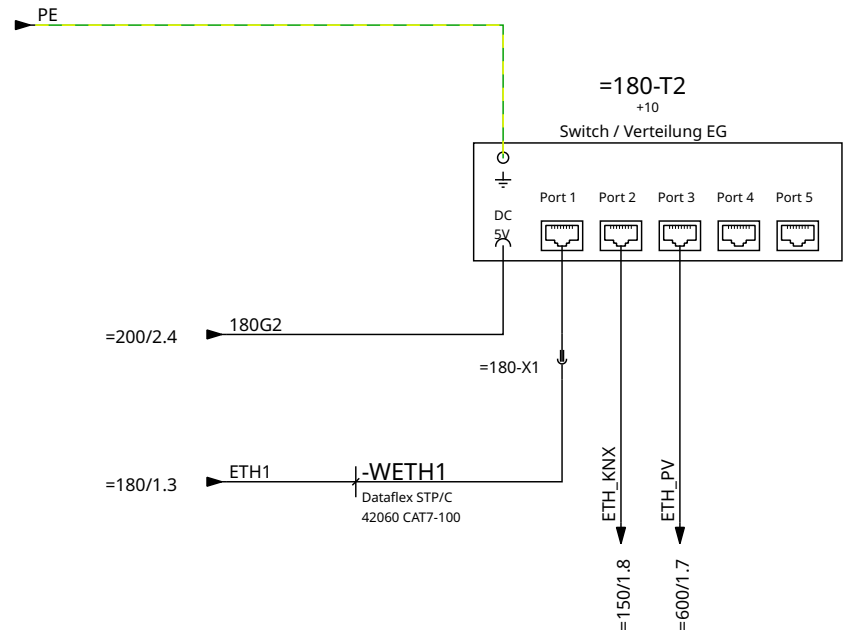
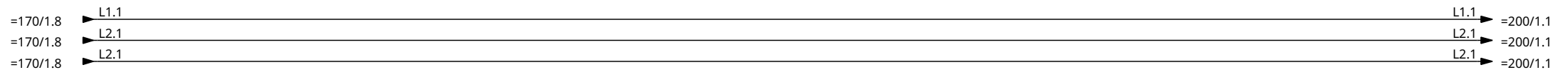

Alle Leitungen ohne Querschnittsangabe sind 1,5mm<sup>2</sup>

c			Druck:	27/05/2020
b			Erstellt:	10/09/2018
a			Gez.	Wendelken
	MODIFICATION	Datum	Gepr.	T.Wendelken

E-Verteilung



Hausverteilung  
Ethernet

2006

.-1  
EIB

=180  
Blatt : 19

2  
19

=190-T1  
+ZD1  
SAT-Antenne  
mit 4fach LNB

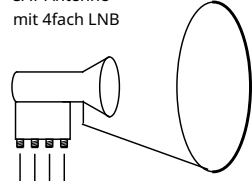

=190-WA01  
Koax LCD 111

=190-WA02  
Koax LCD 111

=190-WA03  
Koax LCD 111

=190-WA04  
Koax LCD 111

=190-XA01  
+Z1  
Sat-Verbinder  
EG

=190-XA02  
+Z1  
Sat-Verbinder  
OG

=190-XA03  
+Z1  
Sat-Verbinder  
OG

SAT1  
=250/4.6  
SAT2  
=250/4.8  
SAT3  
=230/2.8

SAT11  
=340/2.8  
SAT12  
=340/2.6  
SAT13  
=330/2.8  
SAT14  
=330/2.6

SAT15  
=320/2.6  
SAT16  
=320/2.8



c			Druck:	27/05/2020
b			Erstellt:	08/10/2018
a			Gez.	Wendelken
	MODIFICATION	Datum	Name	Gepr.
				T.Wendelken

E-Verteilung



Wendelken

Hausverteilung		.-1	=190	1
Sat-Anlage	2006	EIB	Blatt : 20	20

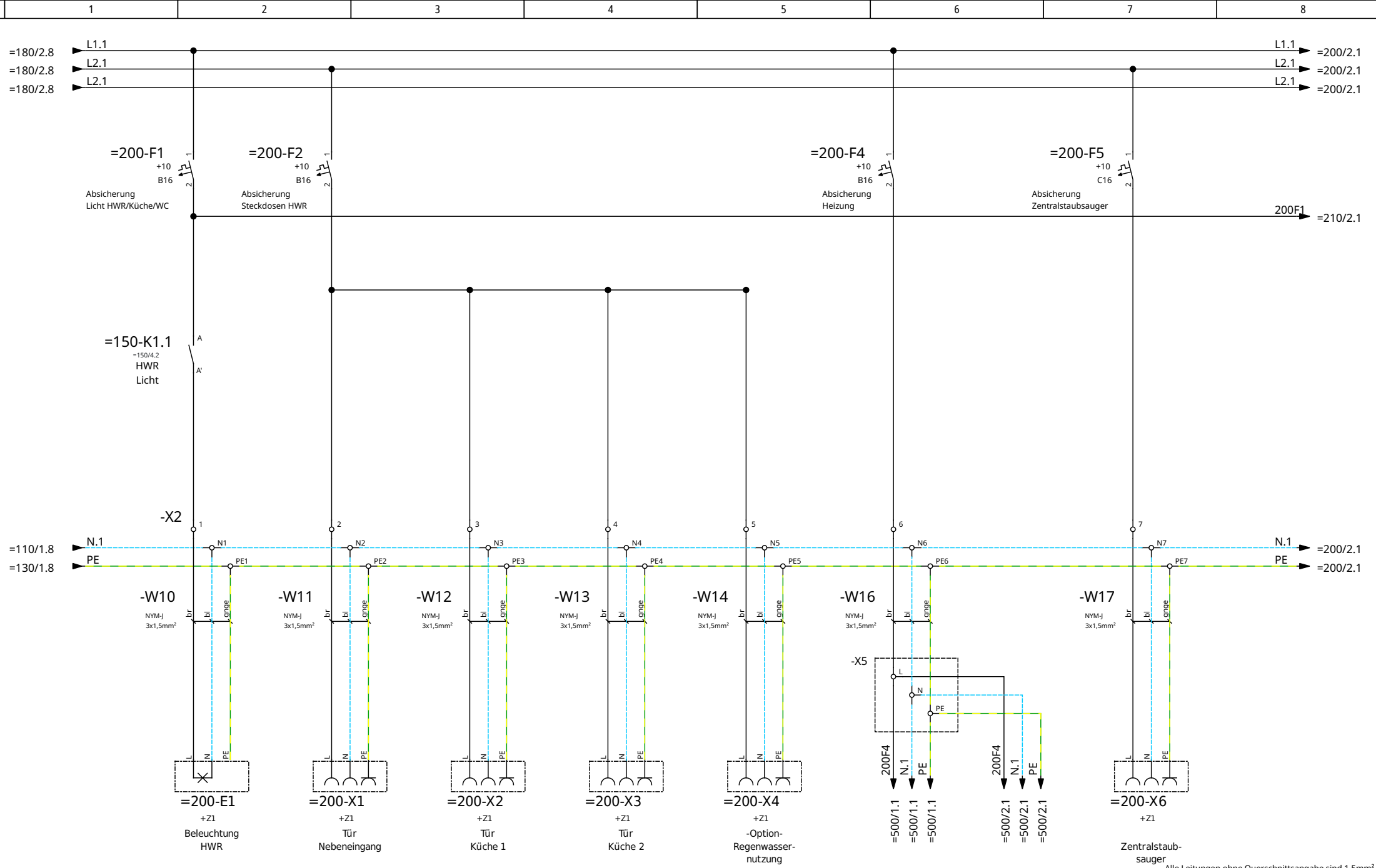

Alle Leitungen ohne Querschnittsangabe sind 1,5mm²

c				Druck:	27/05/2020
b				Erstellt:	10/01/2017
a				Gez.	Wendelken
	MODIFICATION	Datum	Name	Gepr.	T.Wendelken

E-Verteilung	 <b>Wendelken</b>	Hausverteilung	.-1	=200	1
		HWR	2006	EIB	Blatt : 21

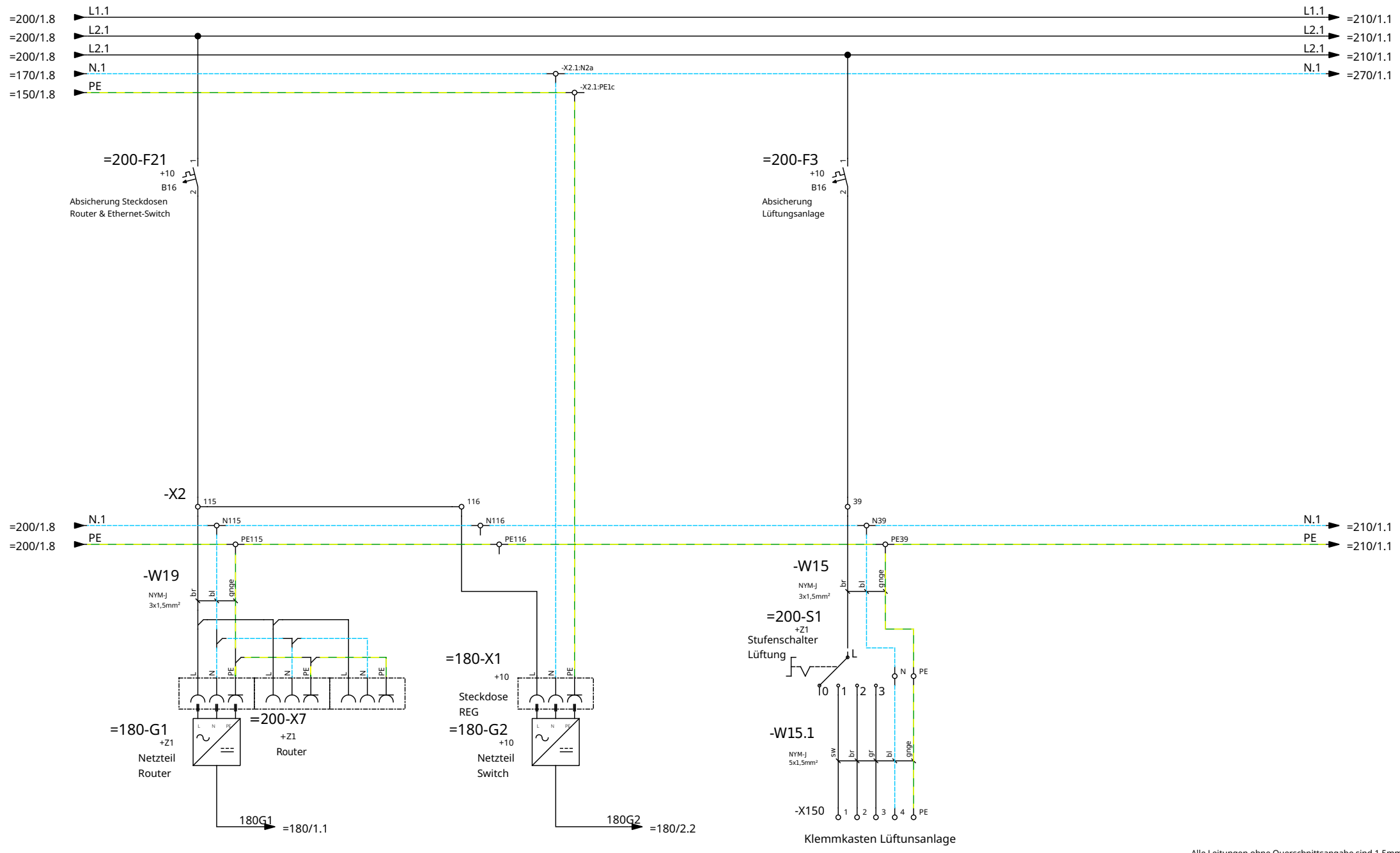

Alle Leitungen ohne Querschnittsangebe sind 1,5mm<sup>2</sup>

c			Druck:	27/05/2020
b			Erstellt:	18/01/2017
a			Gez.	Wendelken
	MODIFICATION	Datum	Name	Gepr.
				T.Wendelken

E-Verteilung

Wendelken

Hausverteilung	.-1	=200	2
HWR	2006	EIB	Blatt : 22

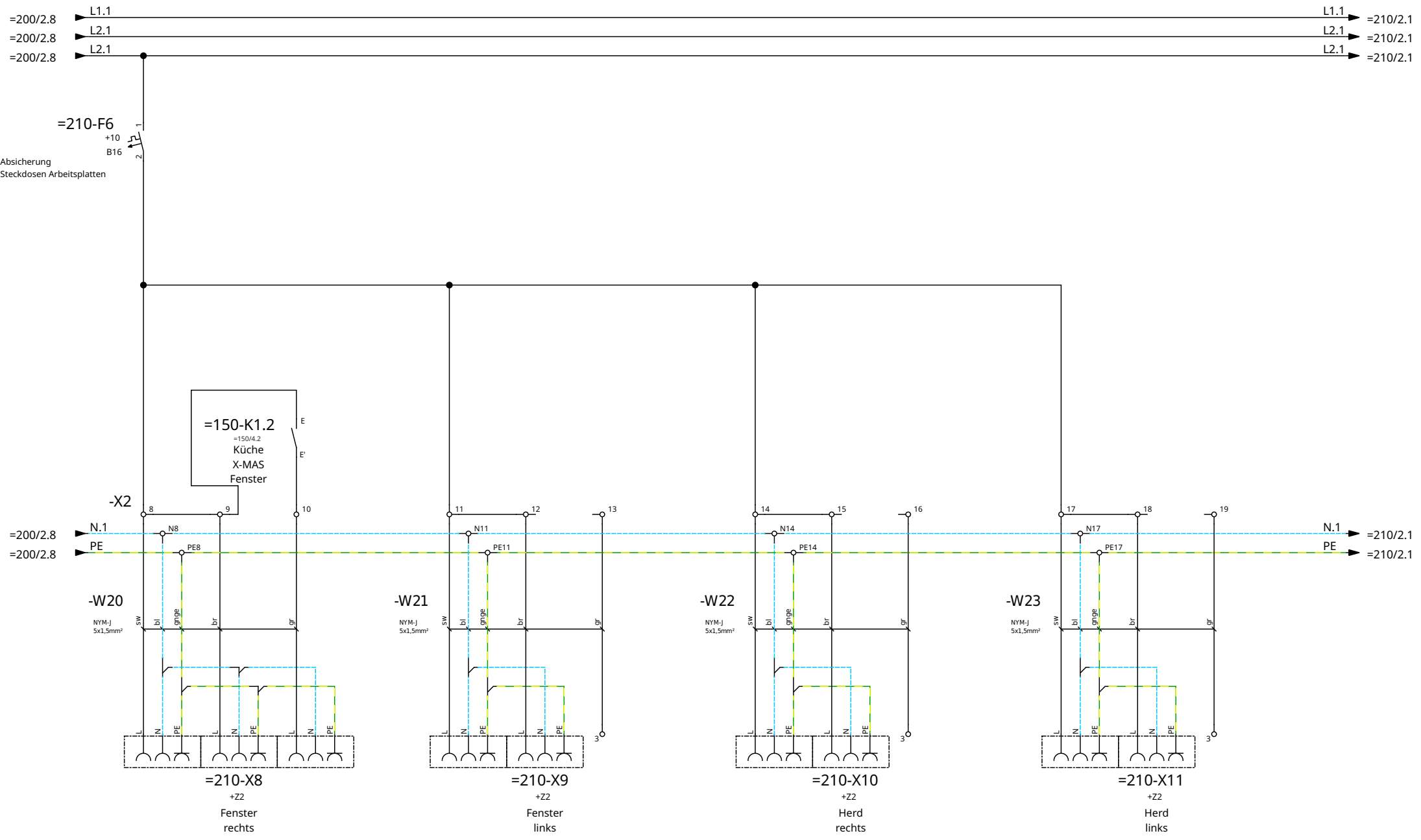

Alle Leitungen ohne Querschnittsangabe sind 1,5mm<sup>2</sup>

c			Druck:	27/05/2020
b			Erstellt:	14/12/2016
a			Gez.	Wendelken
	MODIFICATION	Datum	Name	Gepr.
				T.Wendelken

E-Verteilung



Hausverteilung  
Küche

2006

.-1  
EIB

=210  
Blatt : 23

1  
23

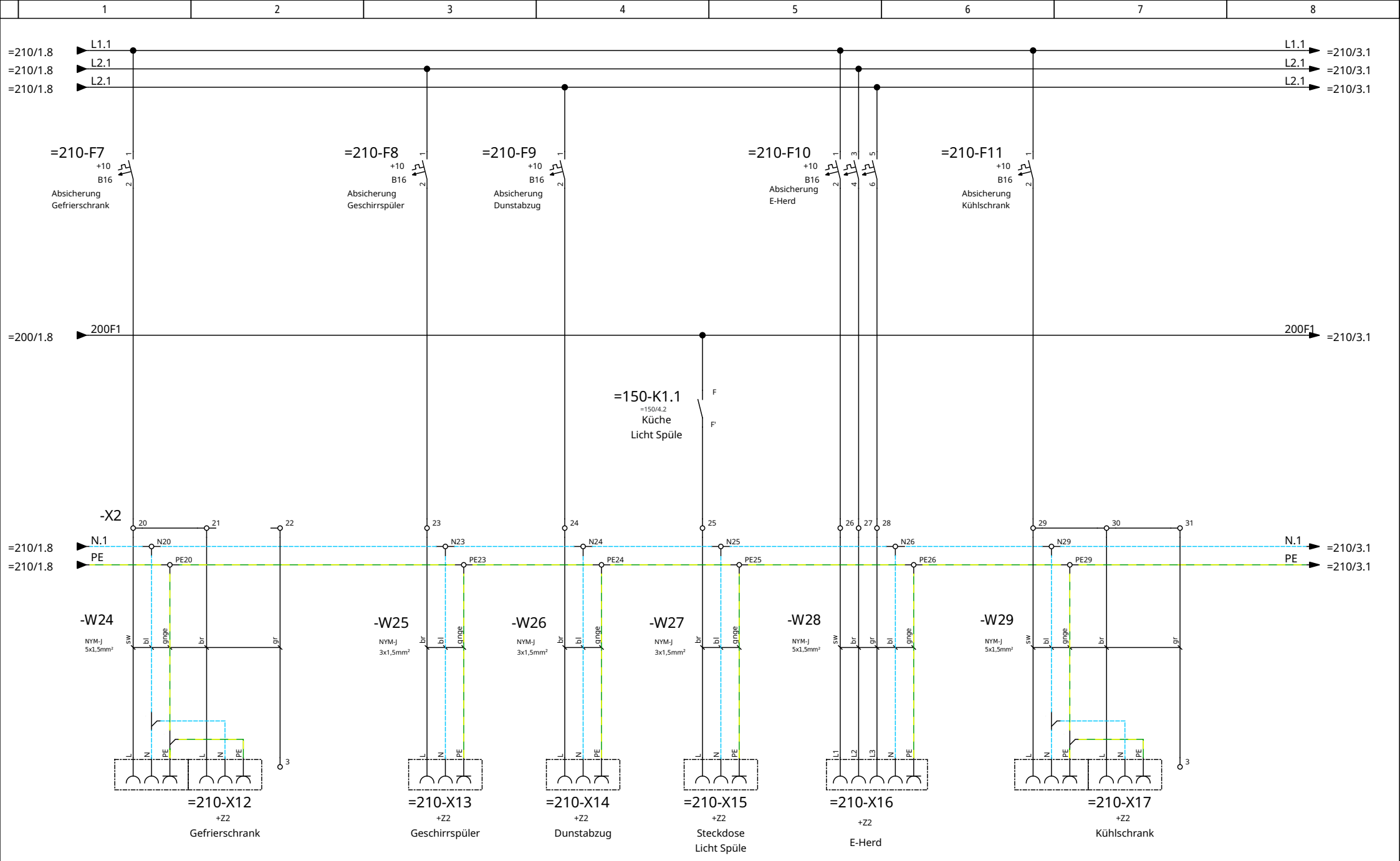

Alle Leitungen ohne Querschnittsangebe sind 1,5mm<sup>2</sup>

c			Druck:	27/05/2020
b			Erstellt:	13/12/2016
a			Gez.	Wendelken
	MODIFICATION	Datum	Name	Gepr.
				T.Wendelken

E-Verteilung



**Wendelken**

Hausverteilung	.-1	=210	2
Küche	2006	EIB	Blatt : 24



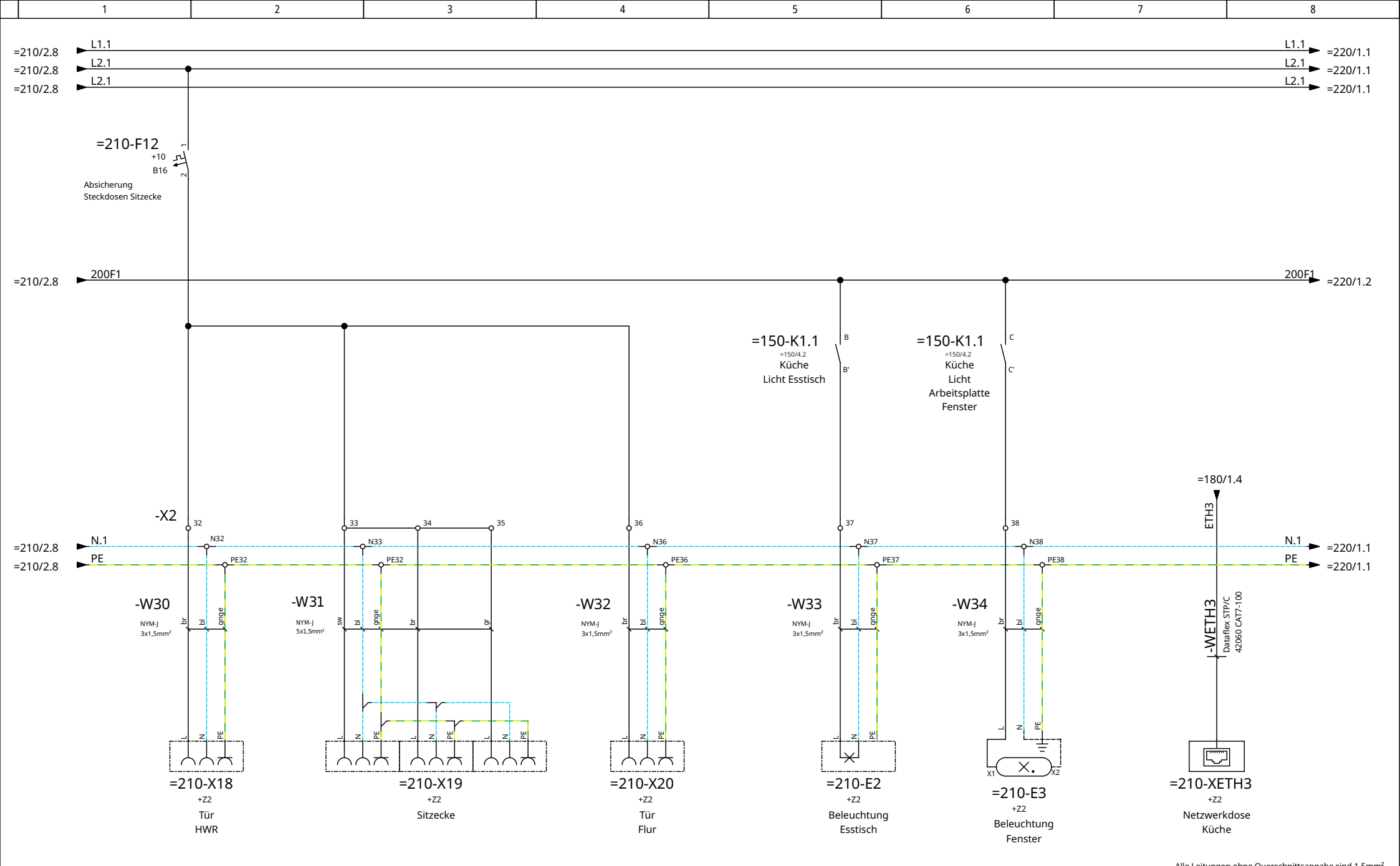

Alle Leitungen ohne Querschnittsangabe sind 1,5mm²

c			Druck:	27/05/2020
b			Erstellt:	17/01/2017
a			Gez.	Wendelken
	MODIFICATION	Datum	Name	Gepr.
				T.Wendelken

E-Verteilung



Hausverteilung  
Küche

2006

.-1  
EIB  
Blatt : 25

=210  
3  
25

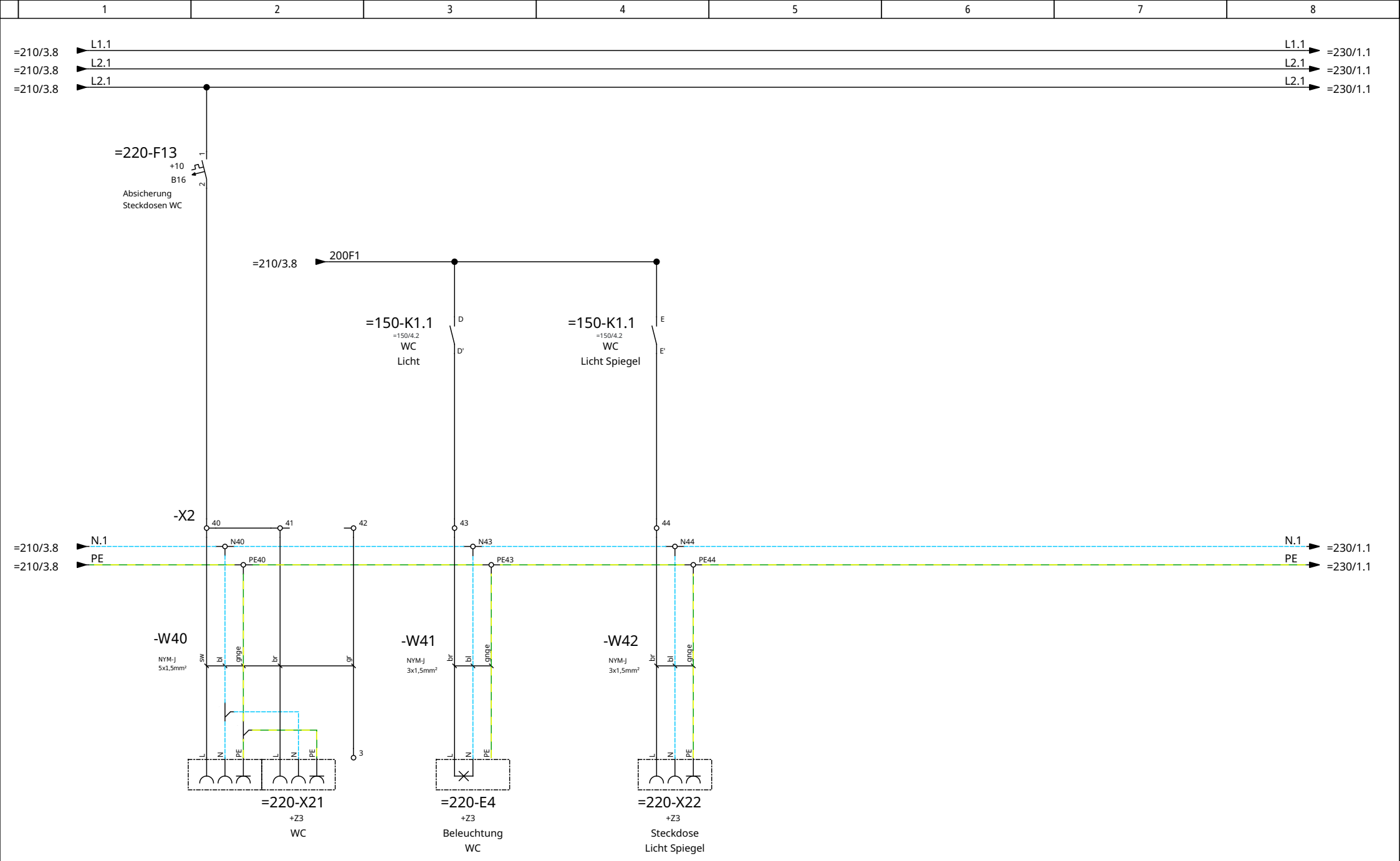

Alle Leitungen ohne Querschnittsangebe sind 1,5mm²

c			Druck:	27/05/2020
b			Erstellt:	16/01/2017
a			Gez.	Wendelken
	MODIFICATION	Datum	Name	Gepr.
				T.Wendelken

E-Verteilung

Wendelken

Hausverteilung		.-1	=220	1
WC	2006	EIB	Blatt : 26	26

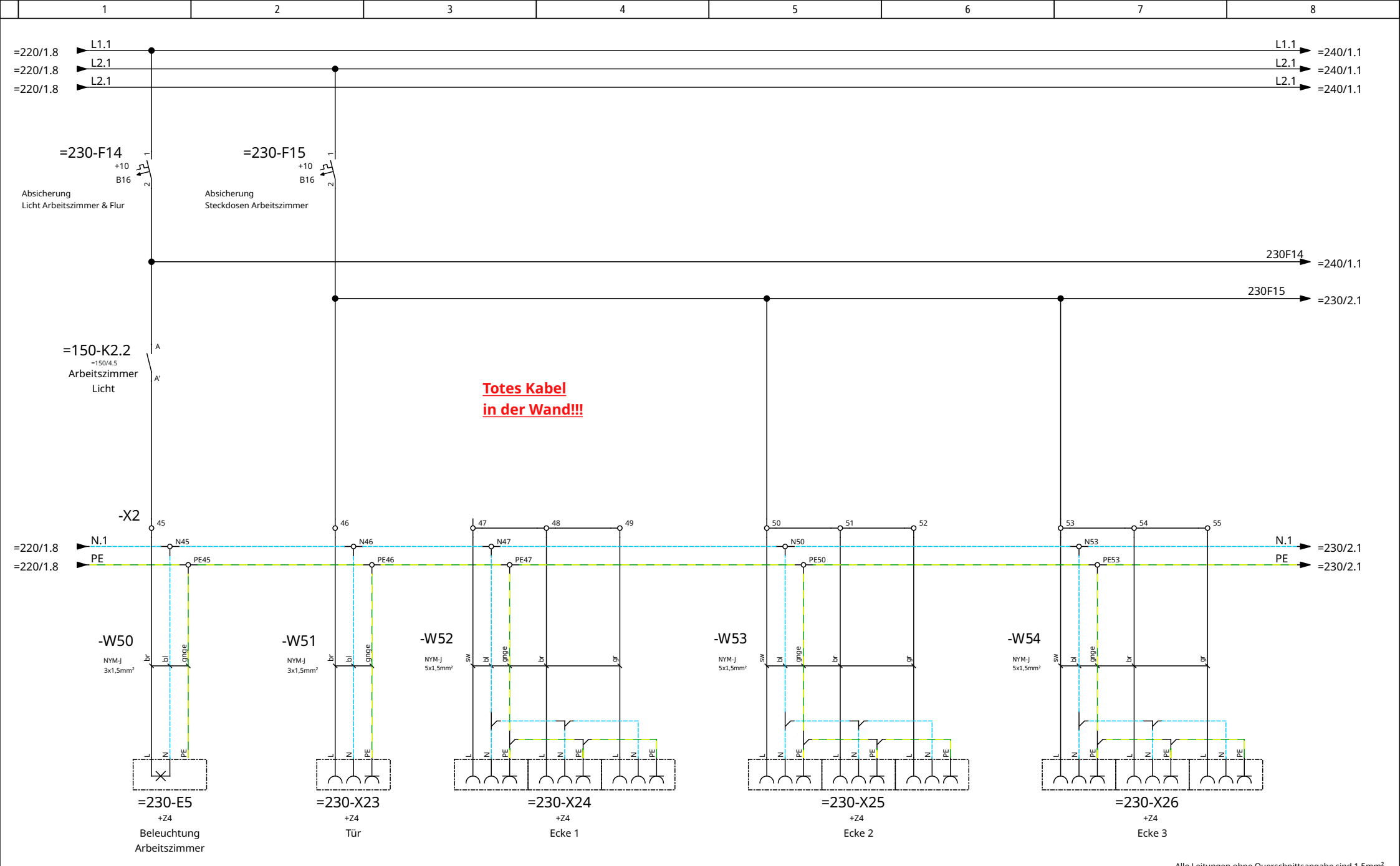

c			Druck:	27/05/2020	<b>E-Verteilung</b>  <b>Wendelken</b>	<b>Hausverteilung</b>	.-1	=230	1
b		Erstellt:	17/01/2017	<b>Arbeitszimmer</b>					
a		Gez.	Wendelken						
	MODIFICATION	Datum	Name	Gepr.		T.Wendelken			



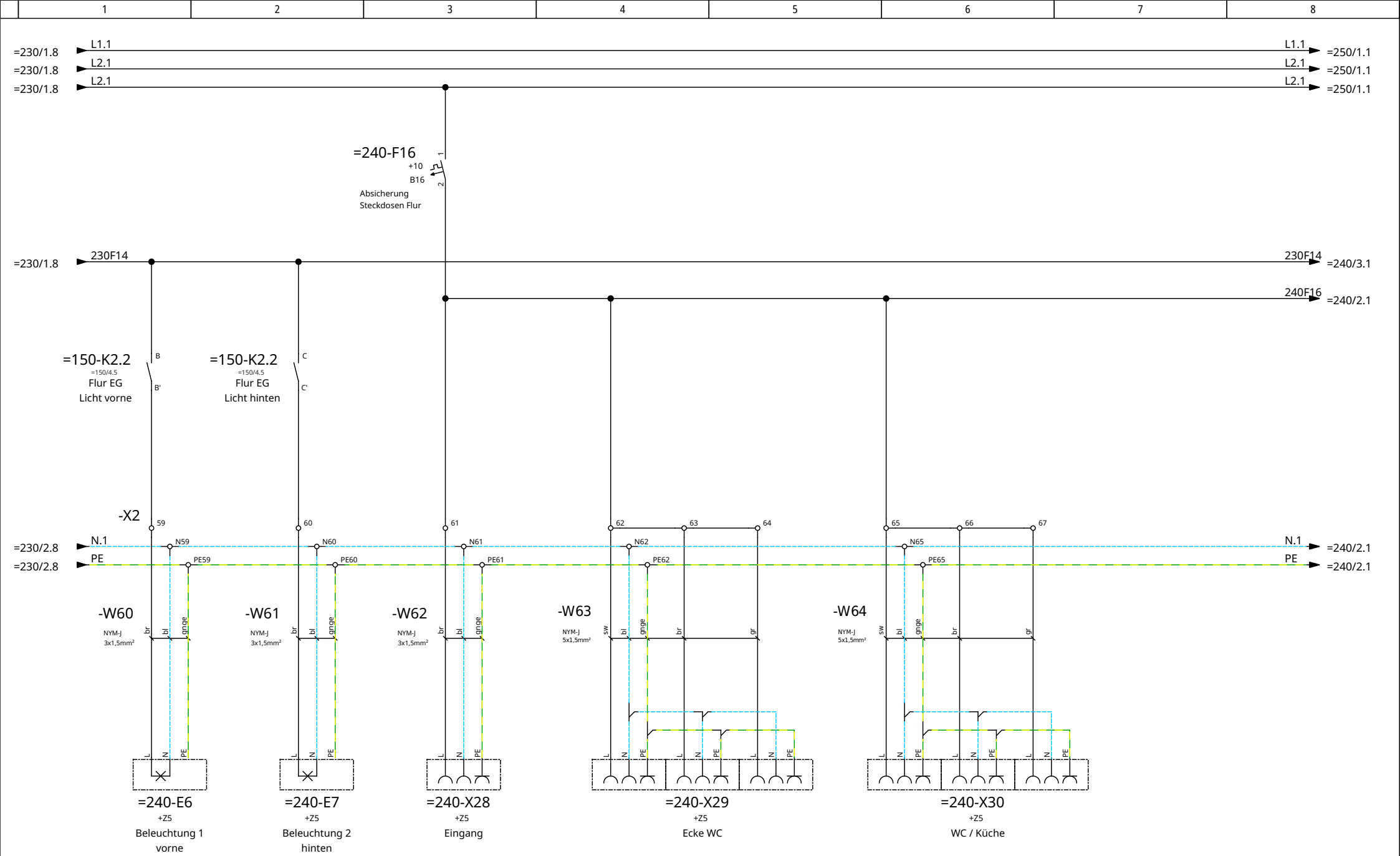

Alle Leitungen ohne Querschnittsangabe sind 1,5mm<sup>2</sup>

c			Druck:	27/05/2020
b			Erstellt:	23/10/2017
a			Gez.	Wendelken
	MODIFICATION	Datum	Name	Gepr.
				T.Wendelken

E-Verteilung



**Wendelken**

Hausverteilung	.-1	=240	1
Flur EG	2006	EIB	Blatt : 29

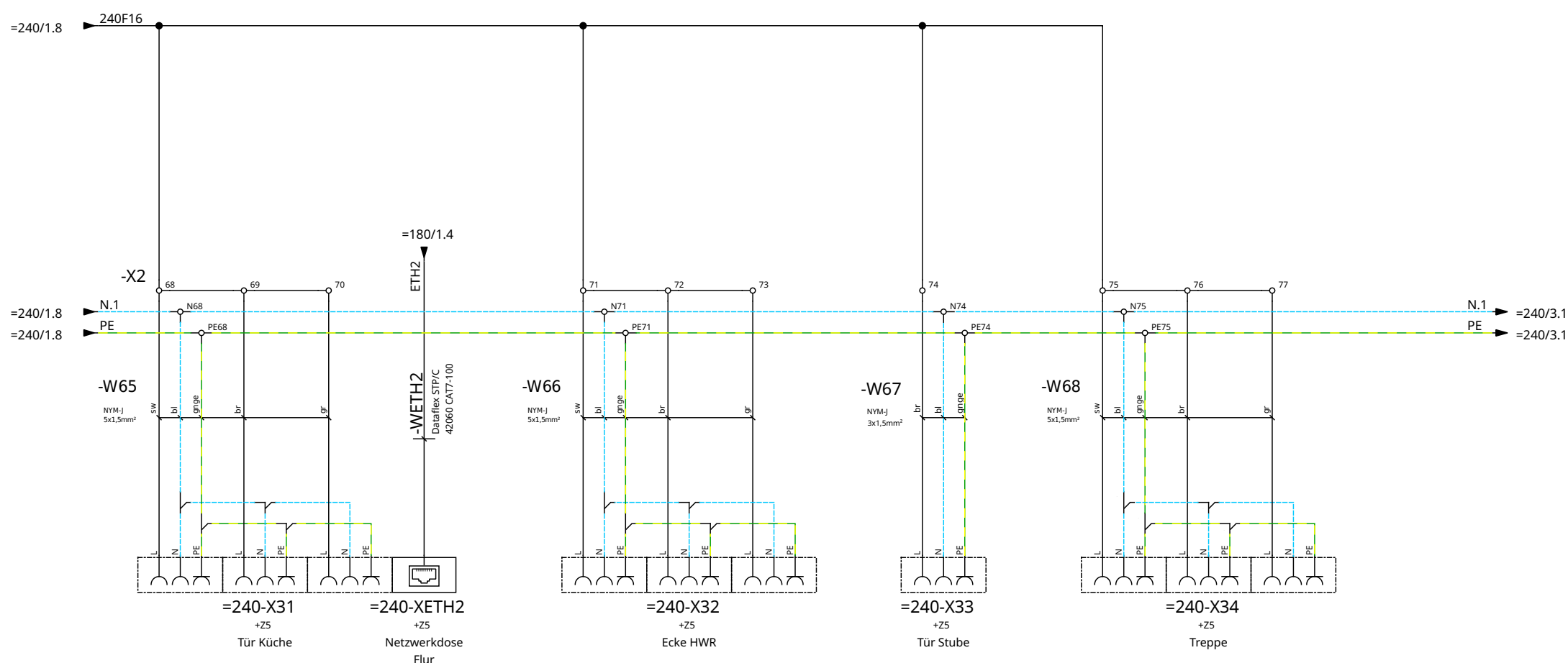

Alle Leitungen ohne Querschnittsangabe sind 1,5mm²

c				Druck:	27/05/2020
b				Erstellt:	23/10/2017
a				Gez.	Wendelken
	MODIFICATION	Datum	Name	Gepr.	T.Wendelken

E-Verteilung



Wendelken

Hausverteilung			.-1	=240	2
Flur EG	2006	EIB	Blatt : 30		30

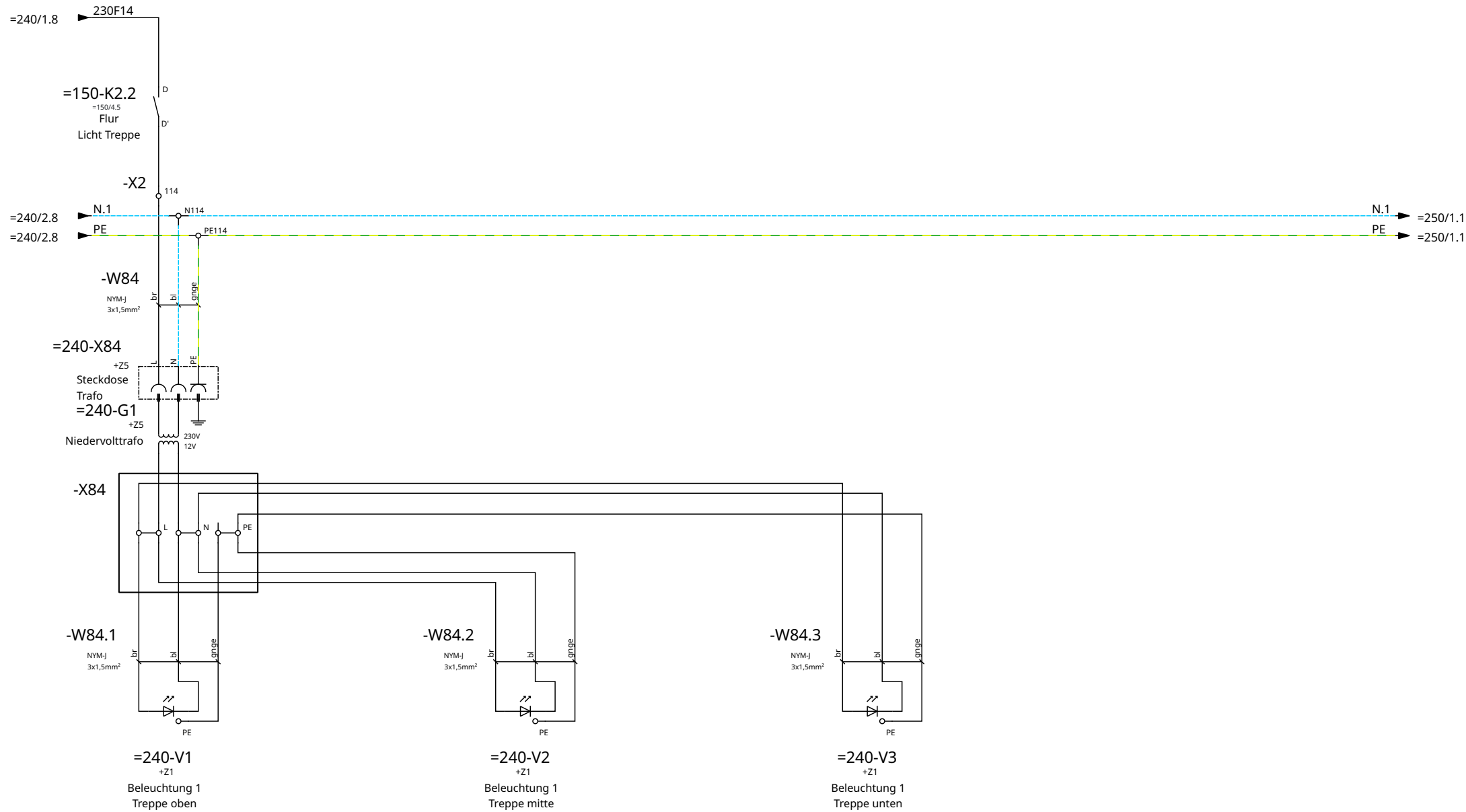

Alle Leitungen ohne Querschnittsangabe sind 1,5mm<sup>2</sup>

c			Druck:	27/05/2020
b			Erstellt:	23/10/2017
a			Gez.	Wendelken
	MODIFICATION	Datum	Name	Gepr.
				T.Wendelken

E-Verteilung

**Wendelken**

Hausverteilung	.-1	=240	3
Flur EG	2006	EIB	Blatt : 31
			31

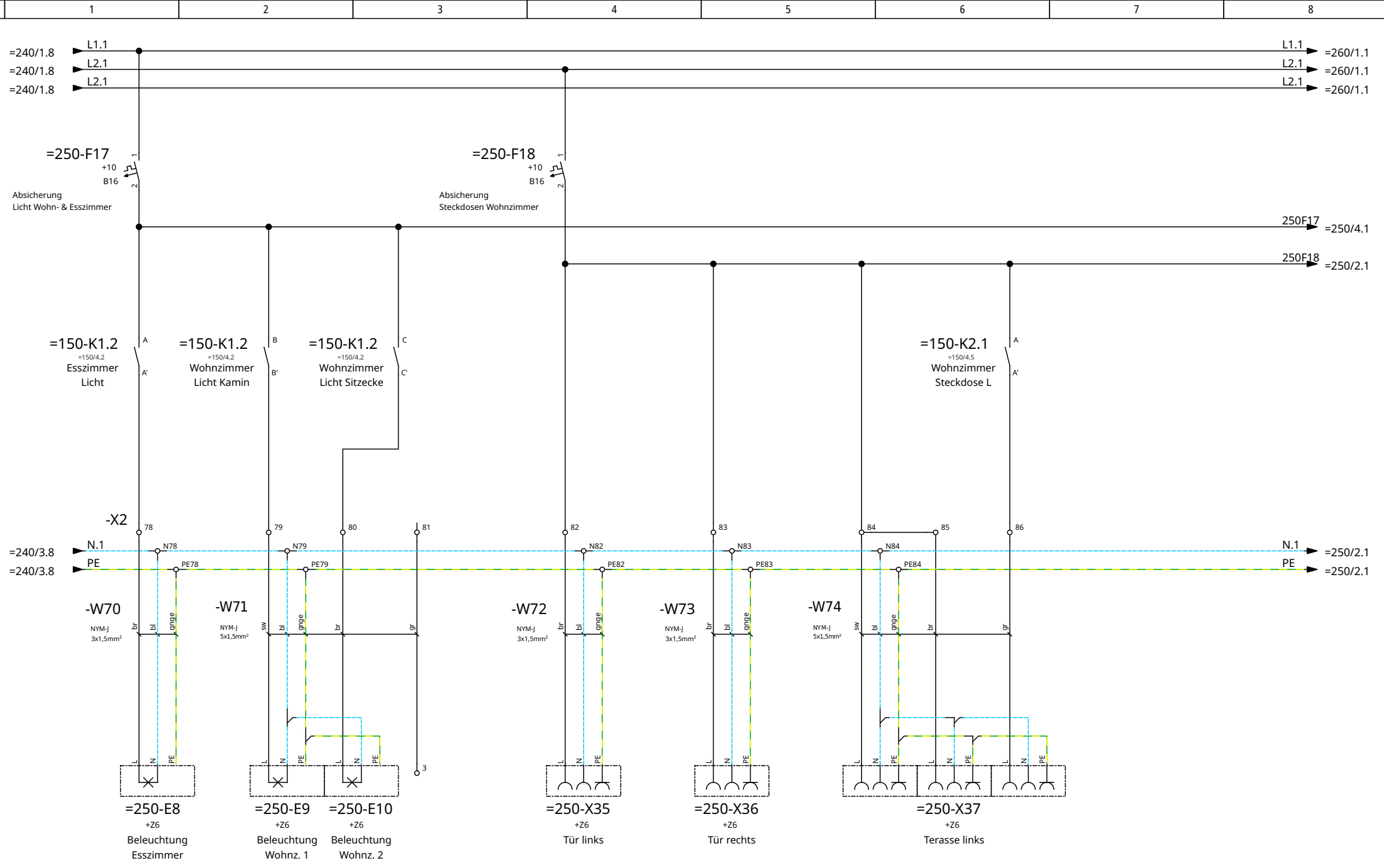

Alle Leitungen ohne Querschnittsangabe sind 1.5mm²

c			Druck:	27/05/2020
b			Erstellt:	24/10/2017
a			Gez.	Wendelken
	MODIFICATION	Datum	Name	Gepr.
				T.Wendelken

E-Verteilung

Wendelken

Hausverteilung	.-1	=250	1
Wohnzimmer	2006	EIB	Blatt : 32



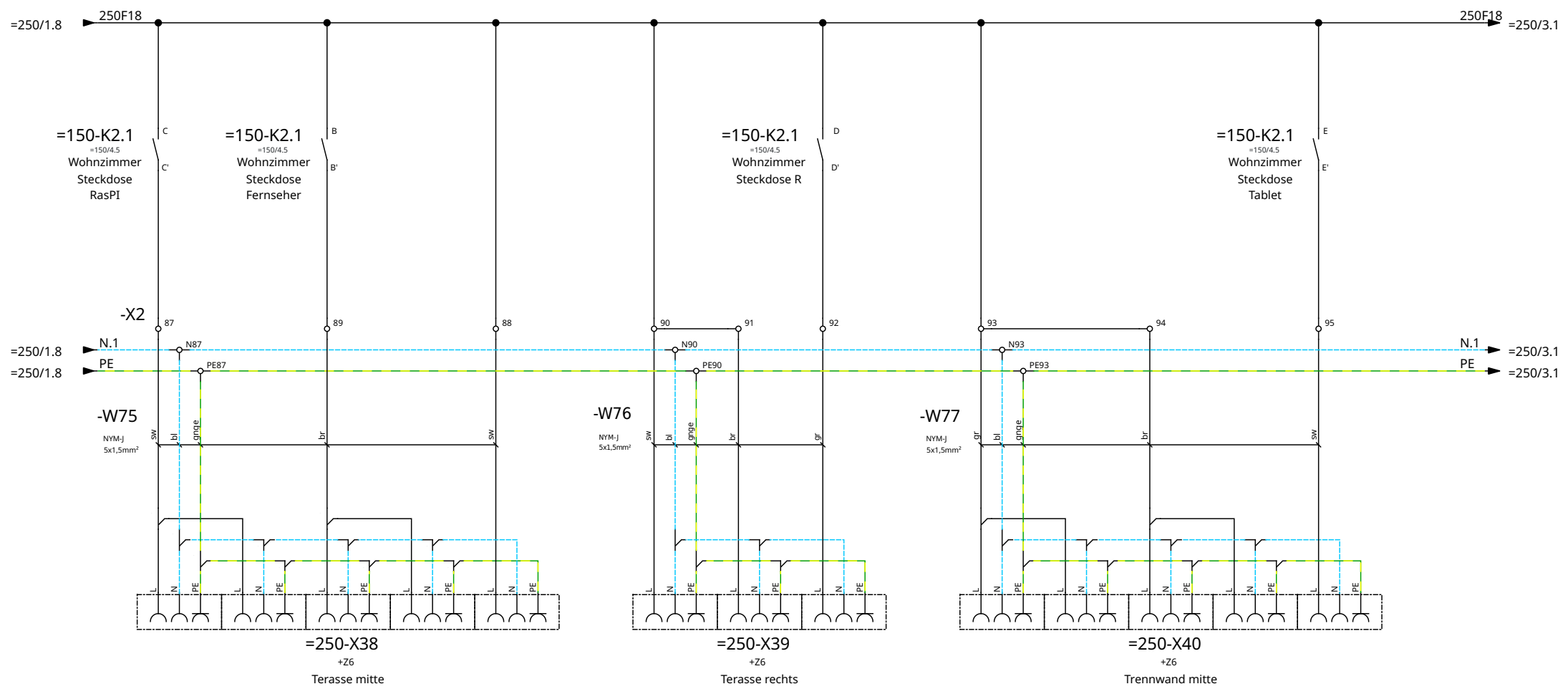

Alle Leitungen ohne Querschnittsangebe sind 1,5mm<sup>2</sup>

c			Druck:	27/05/2020
b			Erstellt:	24/10/2017
a			Gez.	Wendelken
	MODIFICATION	Datum	Name	Gepr.
				T.Wendelken

E-Verteilung



Wendelken

Hausverteilung		.-1	=250	2
Wohnzimmer	2006	EIB	Blatt : 33	33

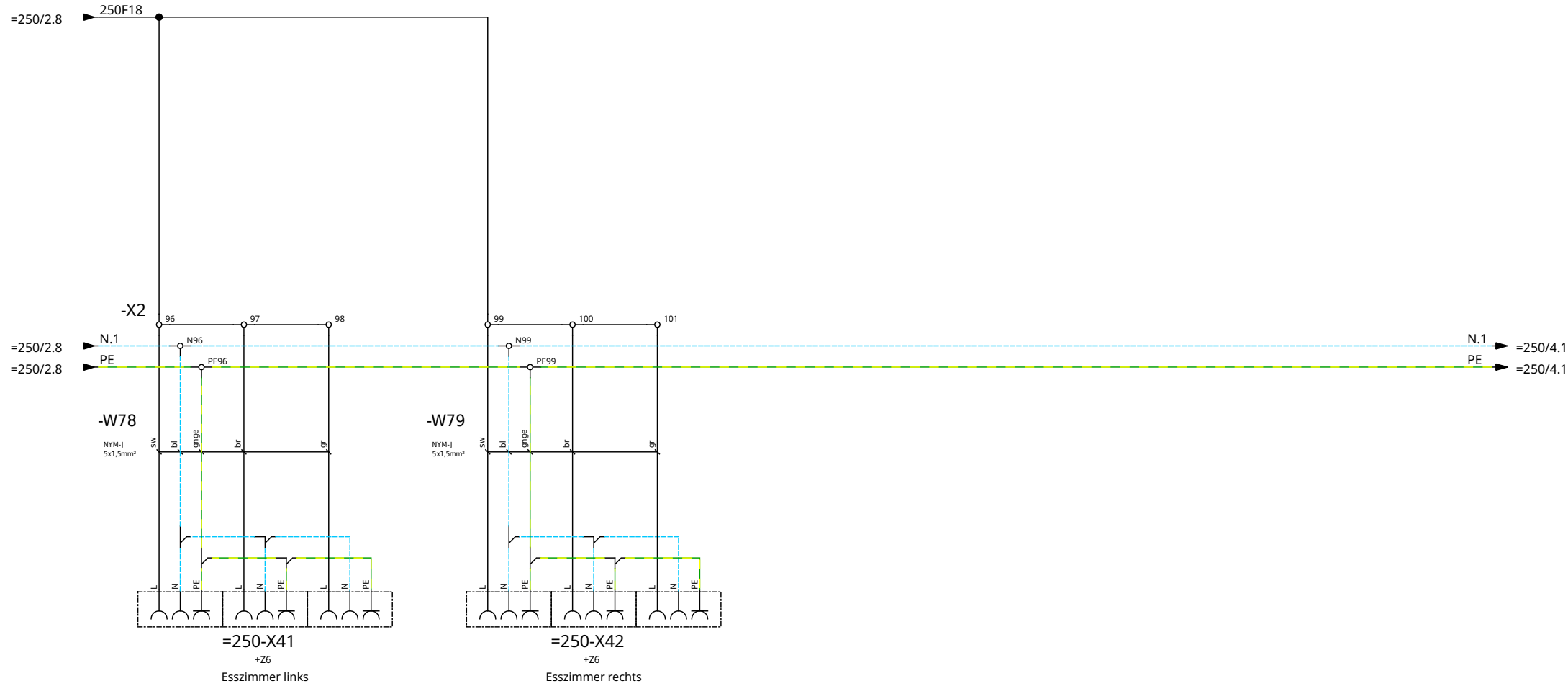

Alle Leitungen ohne Querschnittsangaben sind 1,5mm<sup>2</sup>

c			Druck:	27/05/2020
b			Erstellt:	24/10/2017
a			Gez.	Wendelken
	MODIFICATION	Datum	Name	Gepr.
				T.Wendelken

E-Verteilung



Hausverteilung  
Wohnzimmer

2006

.-1  
EIB

=250  
Blatt : 34

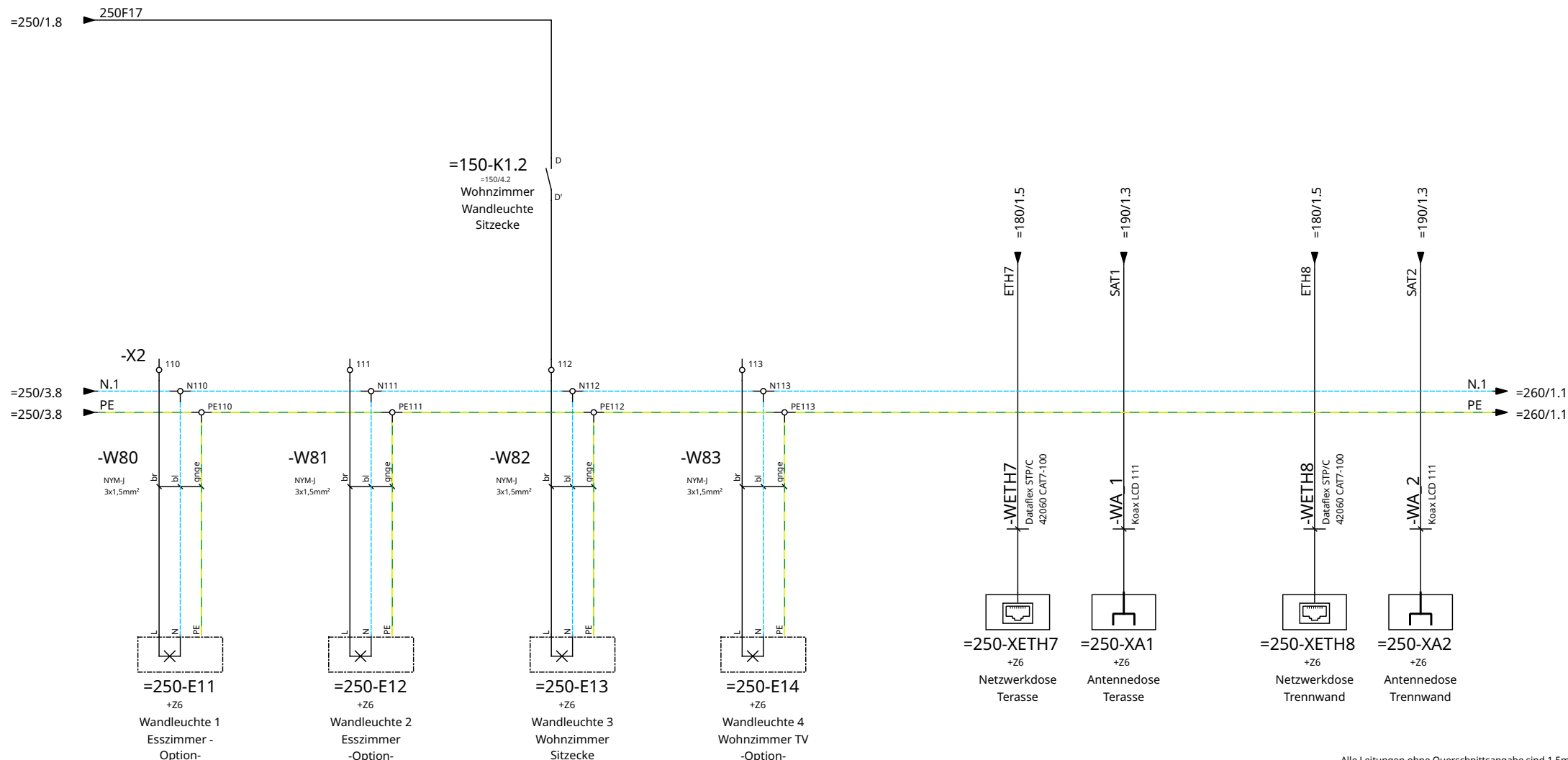

c			Druck:	27/05/2020
b			Erstellt:	24/10/2017
a			Gez.	Wendelken
	MODIFICATION	Datum	Name	Gepr.
				T.Wendelken

E-Verteilung



Wendelken

Hausverteilung				
Wohnzimmer	2006	EIB	Blatt : 35	35

Alle Leitungen ohne Querschnittsangabe sind 1,5mm<sup>2</sup>

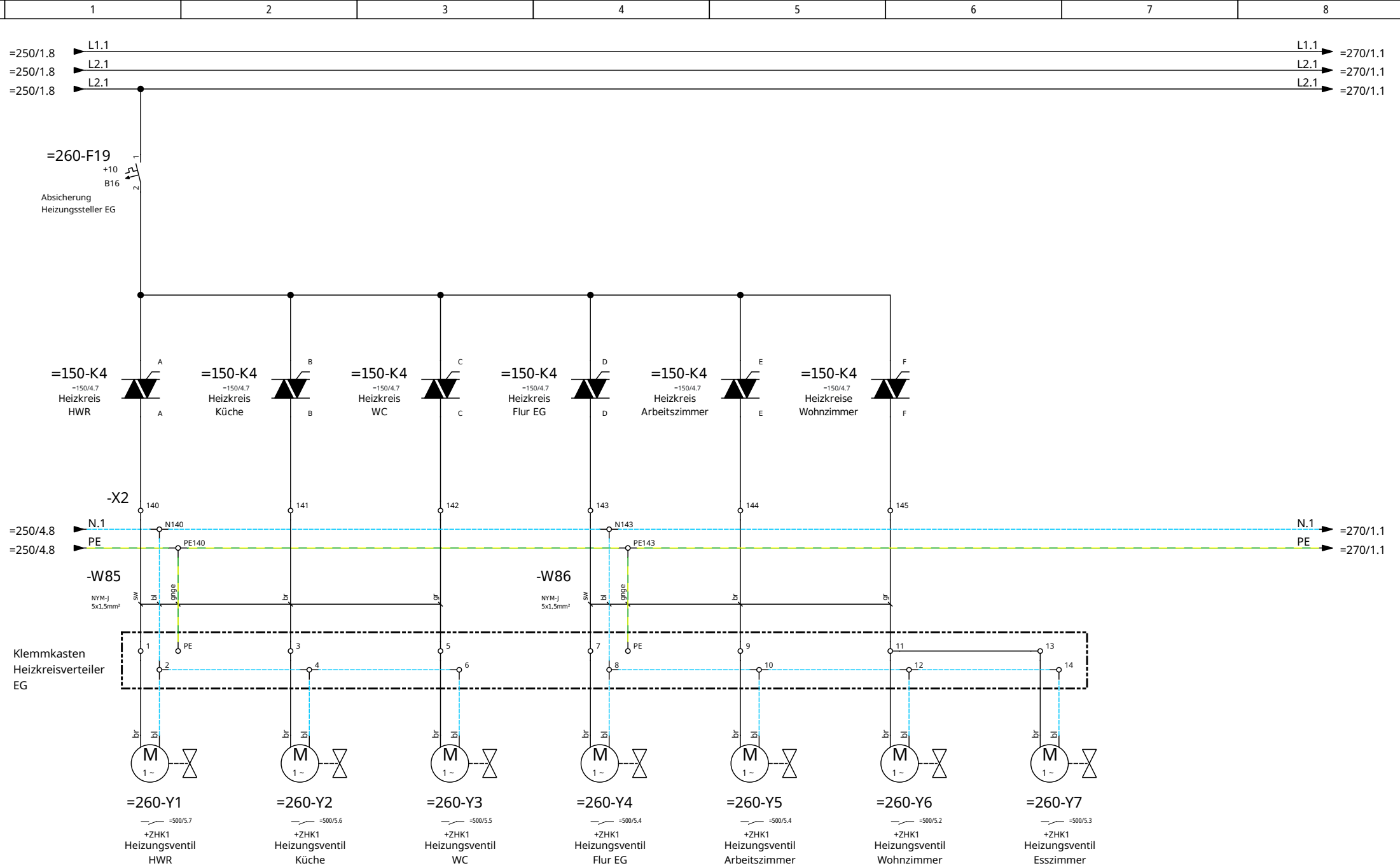

Alle Leitungen ohne Querschnittsangabe sind 1,5mm<sup>2</sup>

c			Druck:	27/05/2020
b			Erstellt:	02/11/2017
a			Gez.	Wendelken
	MODIFICATION	Datum	Name	Gepr.
				T.Wendelken

E-Verteilung



Hausverteilung  
Heizkreisverteiler EG

2006

.-1  
EIB

=260  
Blatt : 36

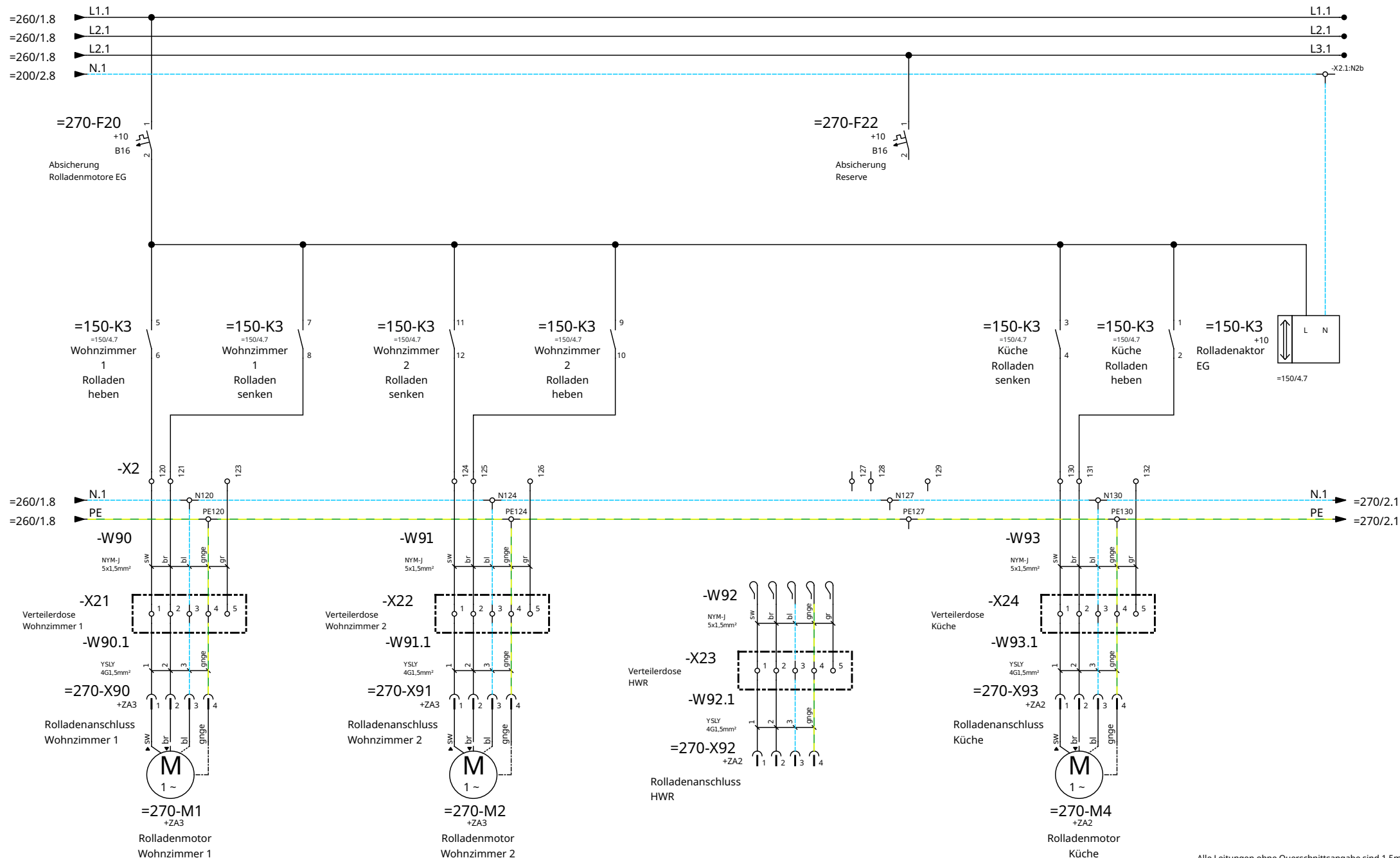

Alle Leitungen ohne Querschnittsangabe sind 1,5mm<sup>2</sup>

c			Druck:	27/05/2020
b			Erstellt:	10/02/2018
a			Gez.	Wendelken
	MODIFICATION	Datum	Name	Gepr.
				T.Wendelken

E-Verteilung

Wendelken

Hausverteilung	.-1	=270	1
Rolläden EG	2006	EIB	Blatt : 37

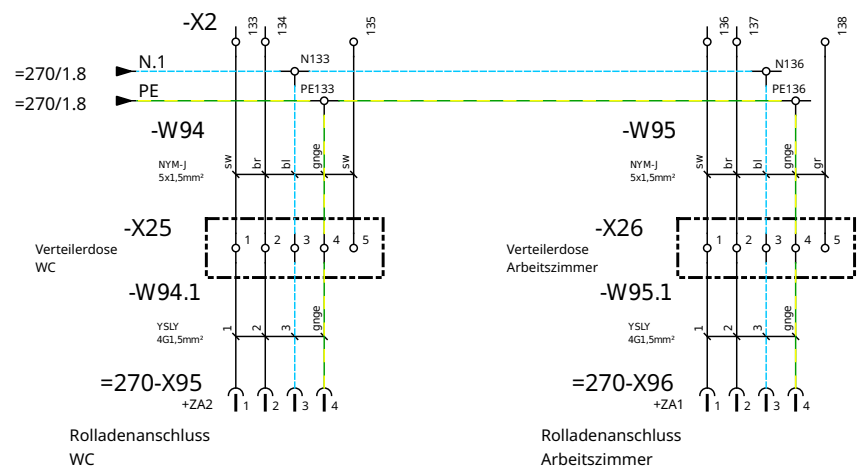

Alle Leitungen ohne Querschnittsangabe sind 1,5mm<sup>2</sup>

c			Druck:	27/05/2020
b			Erstellt:	19/02/2018
a			Gez.	Wendelken
	MODIFICATION	Datum	Name	Gepr.
				T.Wendelken

E-Verteilung

Wendelken

Hausverteilung	.-1	=270	2
Rolläden EG	2006	EIB	Blatt : 38
			38

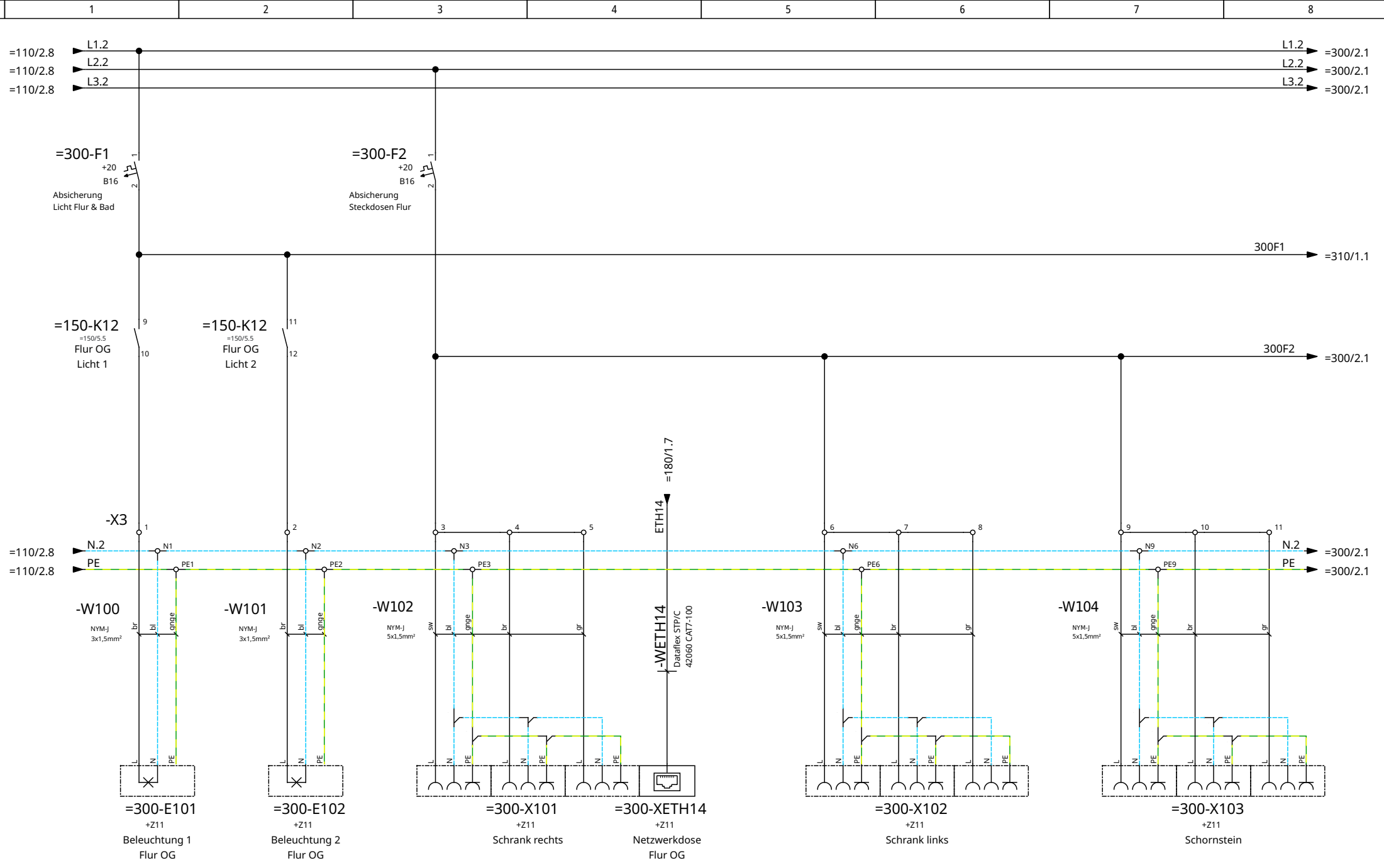

Alle Leitungen ohne Querschnittsangabe sind 1,5mm<sup>2</sup>

c			Druck:	27/05/2020
b			Erstellt:	31/01/2017
a			Gez.	Wendelken
	MODIFICATION	Datum	Name	Gepr.
				T.Wendelken

E-Verteilung



Wendelken

Hausverteilung	.-1	=300	1
Flur OG	2006	EIB	Blatt : 39

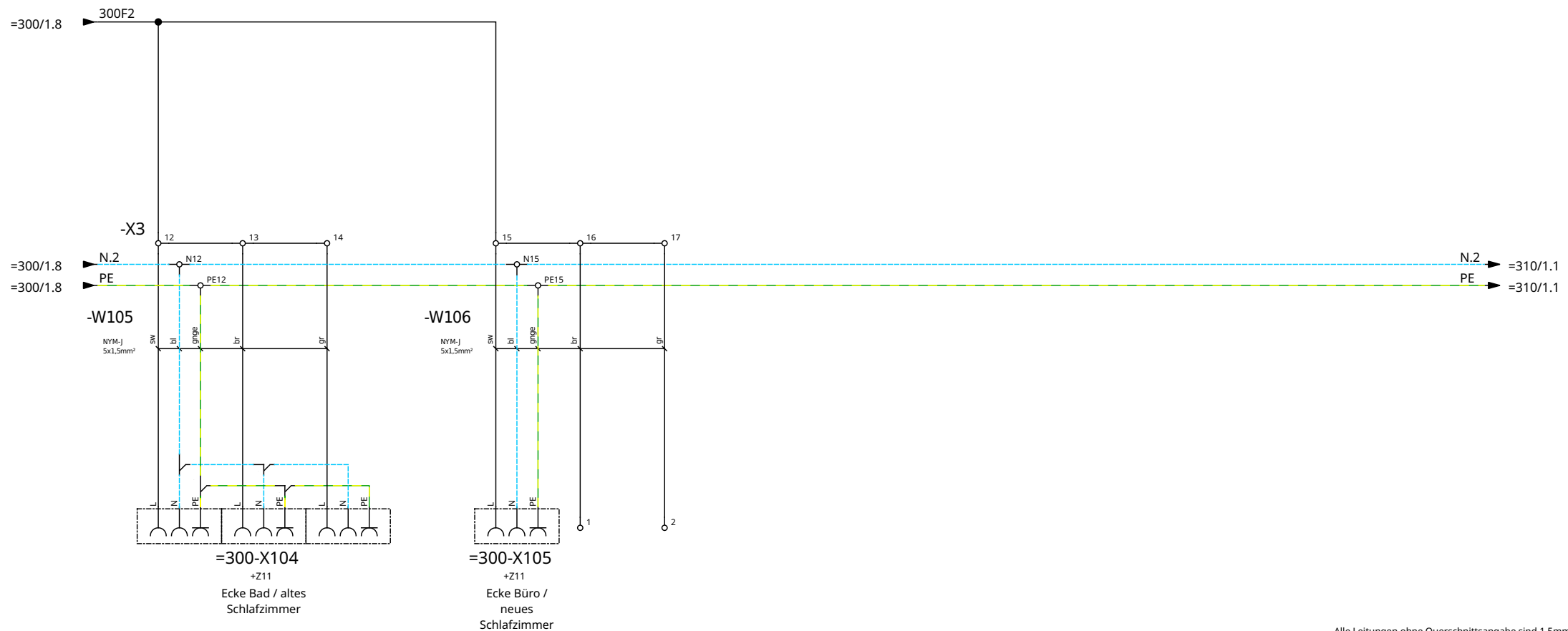
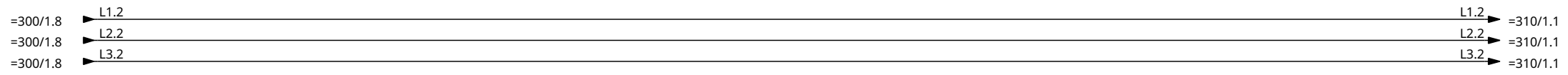

Alle Leitungen ohne Querschnittsangaben sind 1,5mm²

c				Druck:	27/05/2020
b				Erstellt:	31/01/2017
a				Gez.	Wendelken
	MODIFICATION	Datum	Name	Gepr.	T.Wendelken

E-Verteilung



Hausverteilung  
Flur OG

2006

.-1  
EIB

=300  
Blatt : 40

2  
40



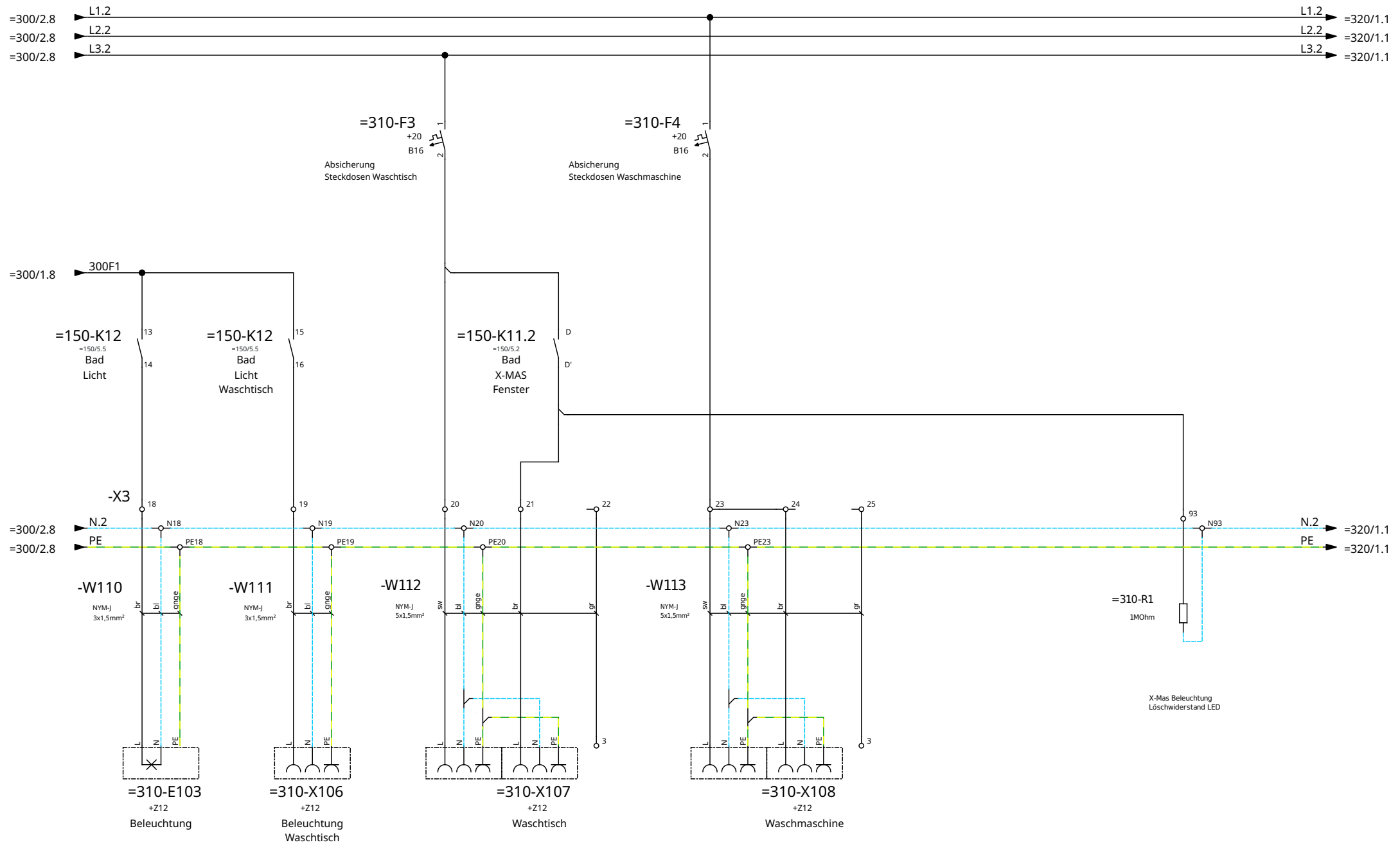

Alle Leitungen ohne Querschnittsangabe sind 1,5mm²

c			Druck:	27/05/2020
b			Erstellt:	31/01/2017
a			Gez.	Wendelken
	MODIFICATION	Datum	Name	Gepr.
				T.Wendelken

E-Verteilung	 Wendelken	Hausverteilung	.-1	=310	1
		Bad	2006	EIB	Blatt : 41

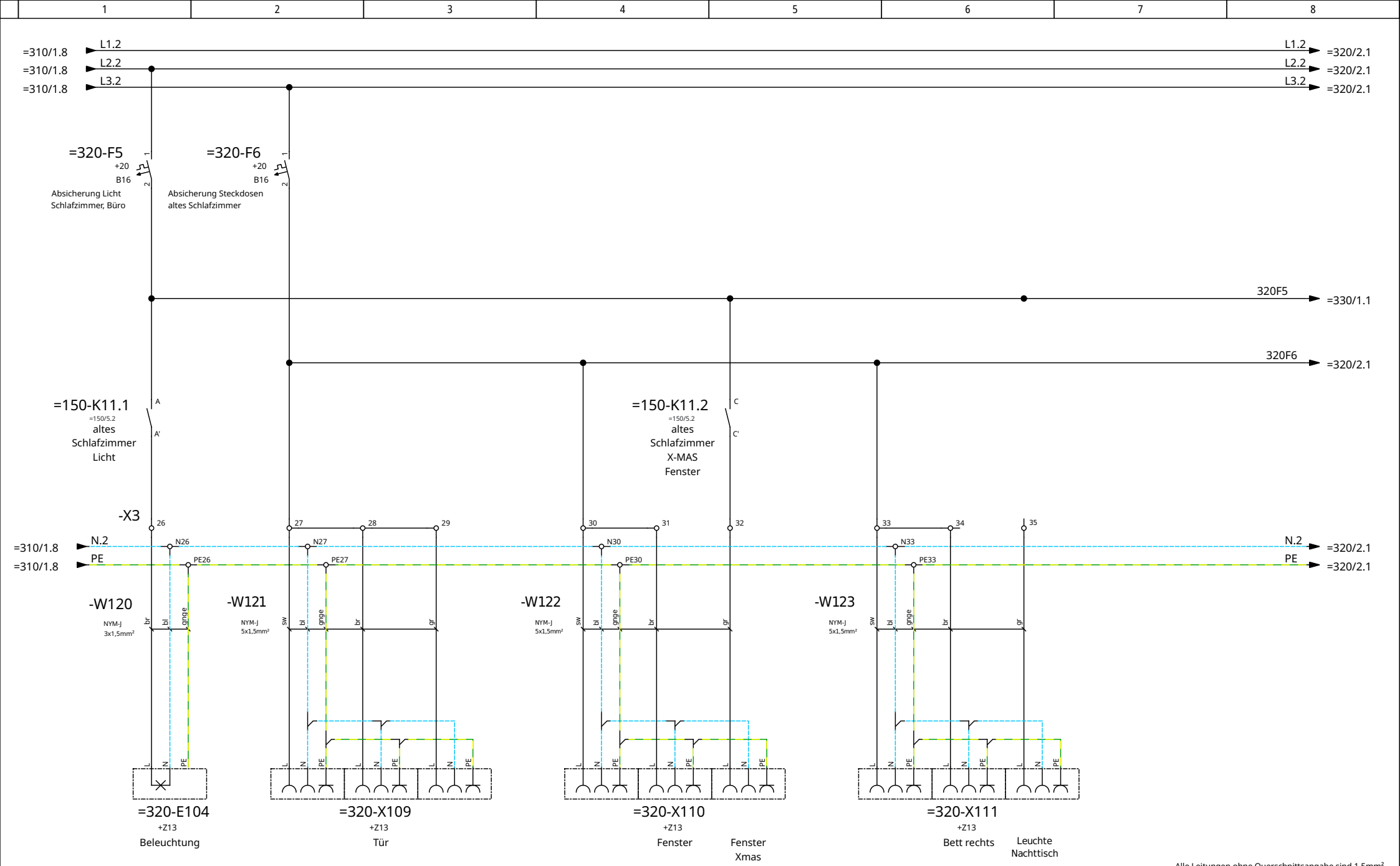

Alle Leitungen ohne Querschnittsangebe sind 1,5mm<sup>2</sup>

c			Druck:	27/05/2020
b			Erstellt:	19/01/2017
a			Gez.	Wendelken
	MODIFICATION	Datum	Name	Gepr.
				T.Wendelken

E-Verteilung



Hausverteilung  
altes Schlafzimmer

2006

.-1  
EIB

=320  
Blatt : 42

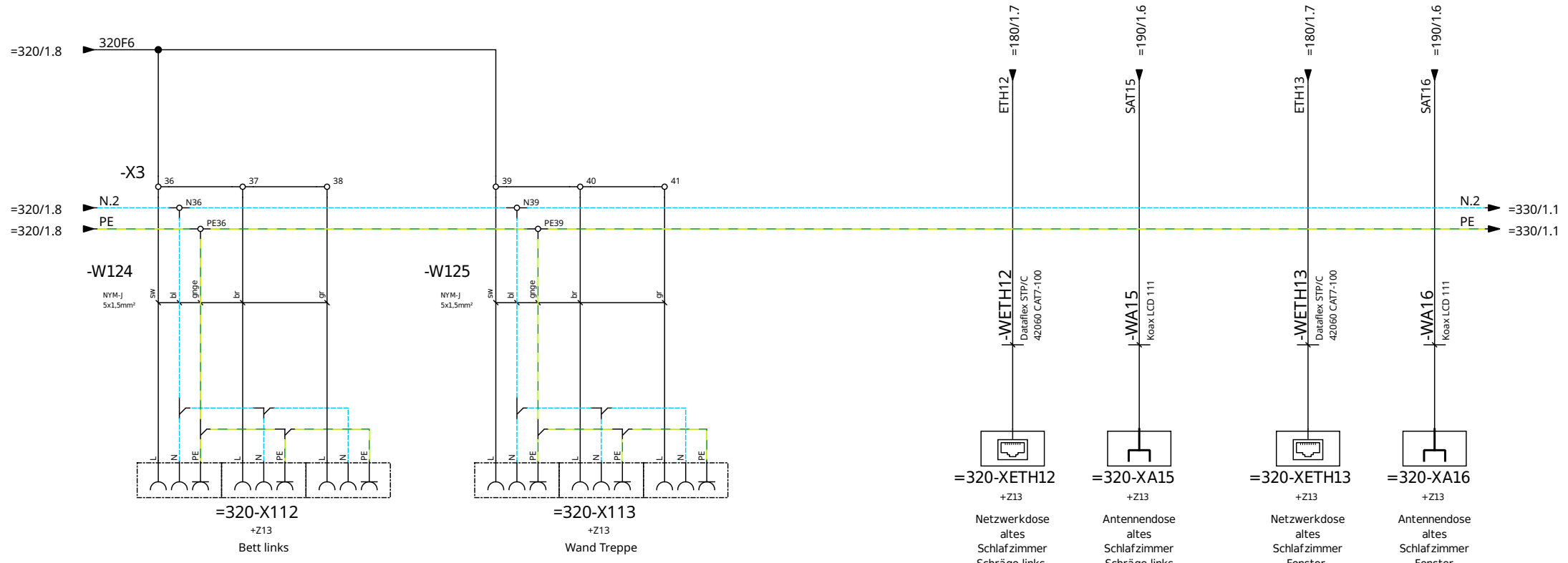
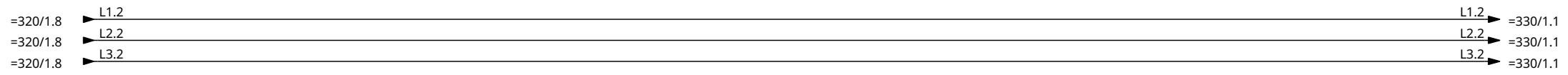

c			Druck:	27/05/2020
b			Erstellt:	19/01/2017
a			Gez.	Wendelken
	MODIFICATION	Datum	Name	Gepr.
				T.Wendelken

E-Verteilung

**Wendelken**

Hausverteilung	.-1	=320	2
altes Schlafzimmer	2006	EIB	Blatt : 43

Alle Leitungen ohne Querschnittsangabe sind 1,5mm<sup>2</sup>

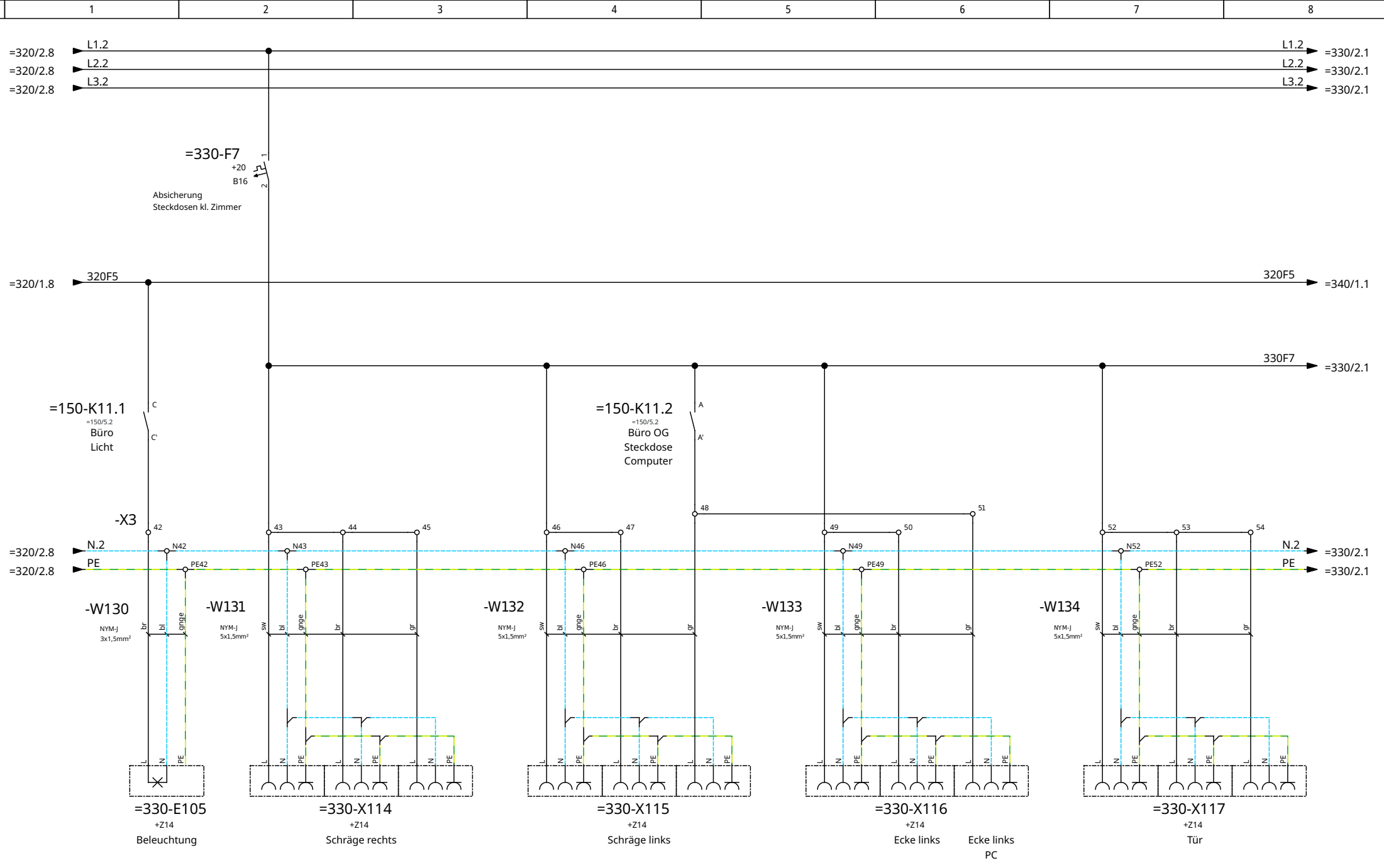

Alle Leitungen ohne Querschnittsangabe sind 1,5mm<sup>2</sup>

c			Druck:	27/05/2020
b			Erstellt:	23/01/2017
a			Gez.	Wendelken
	MODIFICATION	Datum	Name	Gepr.
				T.Wendelken

E-Verteilung

Wendelken

Hausverteilung	.-1	=330	1
Büro OG	2006	EIB	Blatt : 44
			44

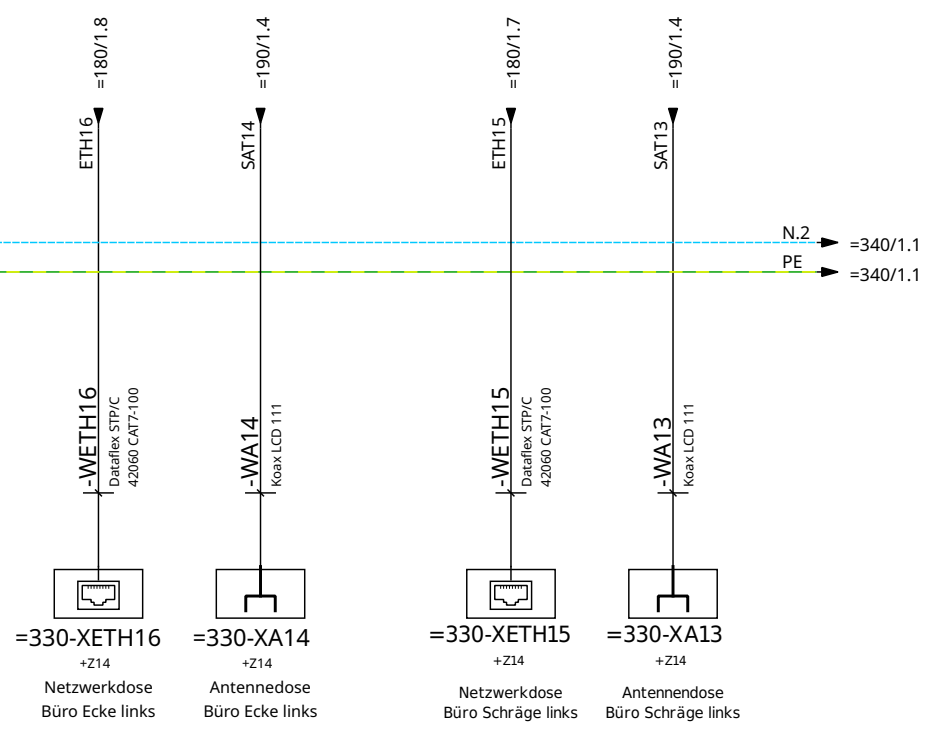
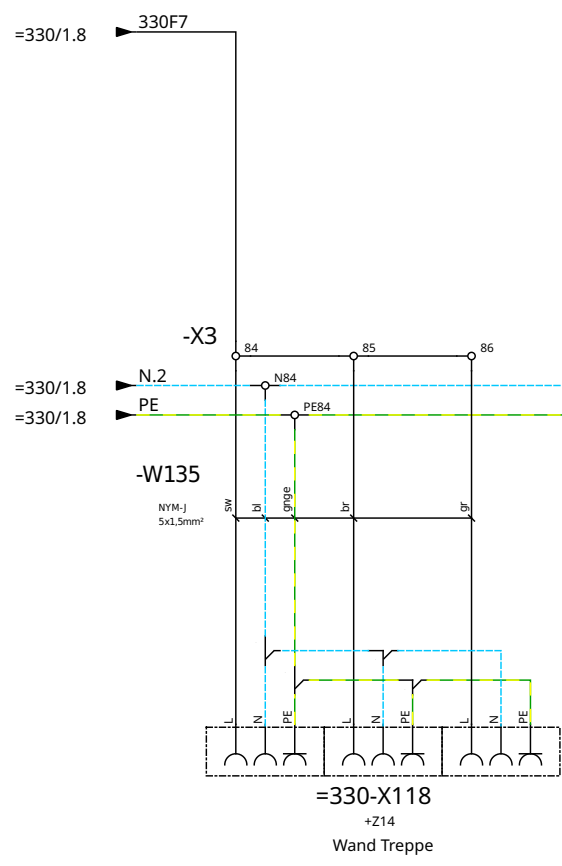
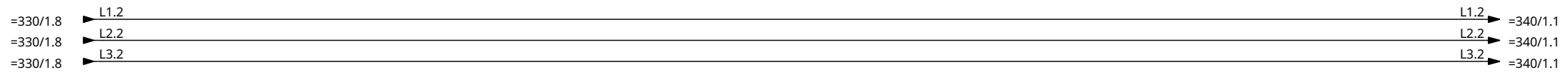

Alle Leitungen ohne Querschnittsangabe sind 1,5mm²

c			Druck:	27/05/2020
b			Erstellt:	23/01/2017
a			Gez.	Wendelken
	MODIFICATION	Datum	Name	Gepr.
				T.Wendelken

E-Verteilung		Hausverteilung		.-1	=330	2
		Büro OG				

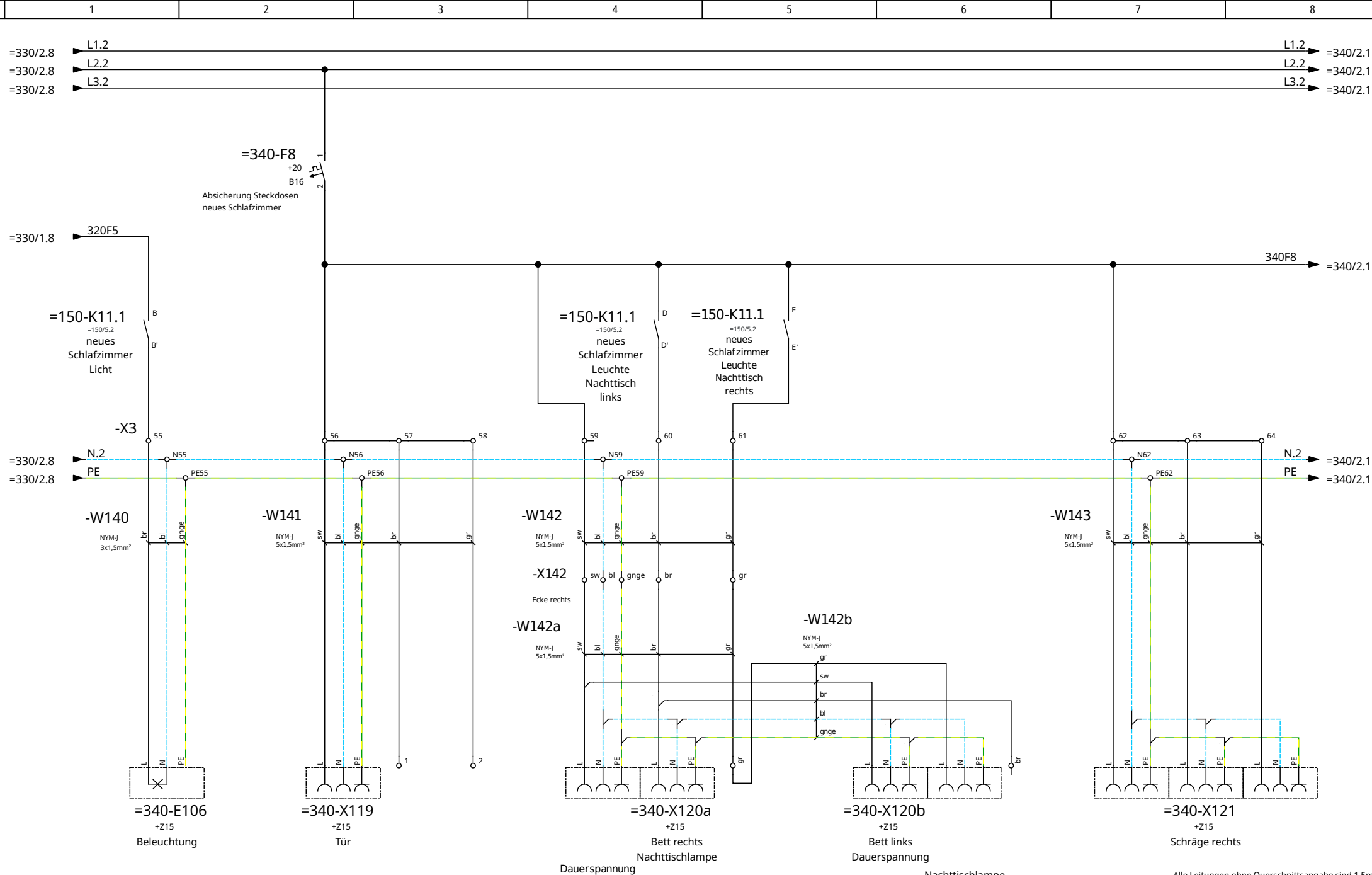

c			Druck:	27/05/2020
b			Erstellt:	23/01/2017
a			Gez.	Wendelken
	MODIFICATION	Datum	Name	Gepr.
				T. Wendelken

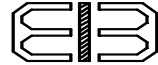
E-Verteilung	 Wendelken	Hausverteilung	.-1	=340	1
		neues Schlafzimmer	2006	EIB	Blatt : 46

Alle Leitungen ohne Querschnittsangabe sind 1,5mm²

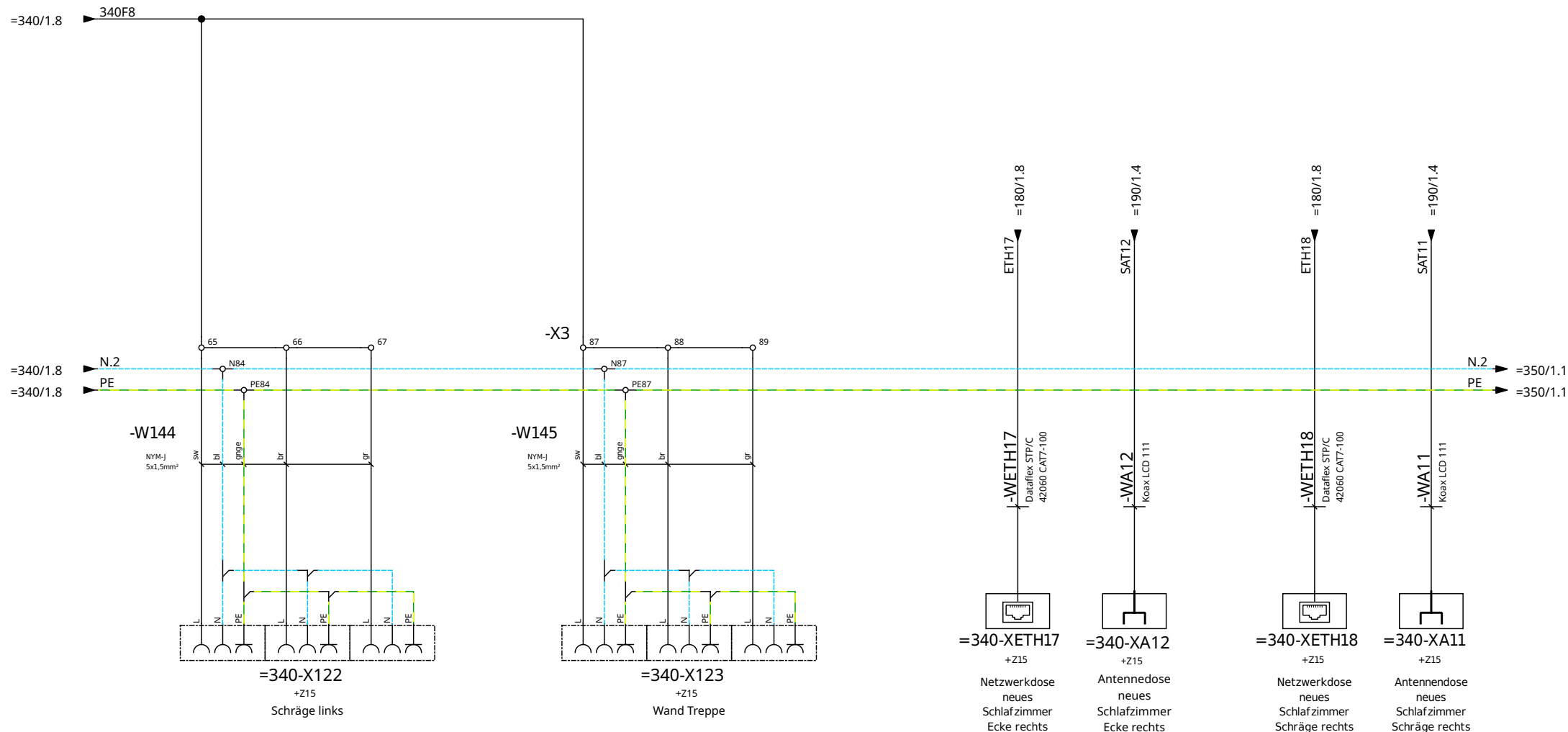
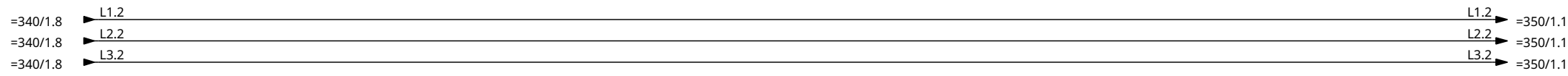

c			Druck:	27/05/2020
b			Erstellt:	23/01/2017
a			Gez.	Wendelken
	MODIFICATION	Datum	Name	Gepr.
				T.Wendelken

E-Verteilung

Wendelken

Hausverteilung				
neues Schlafzimmer	2006	.-1	EIB	=340 Blatt : 47

Alle Leitungen ohne Querschnittsangabe sind 1,5mm<sup>2</sup>

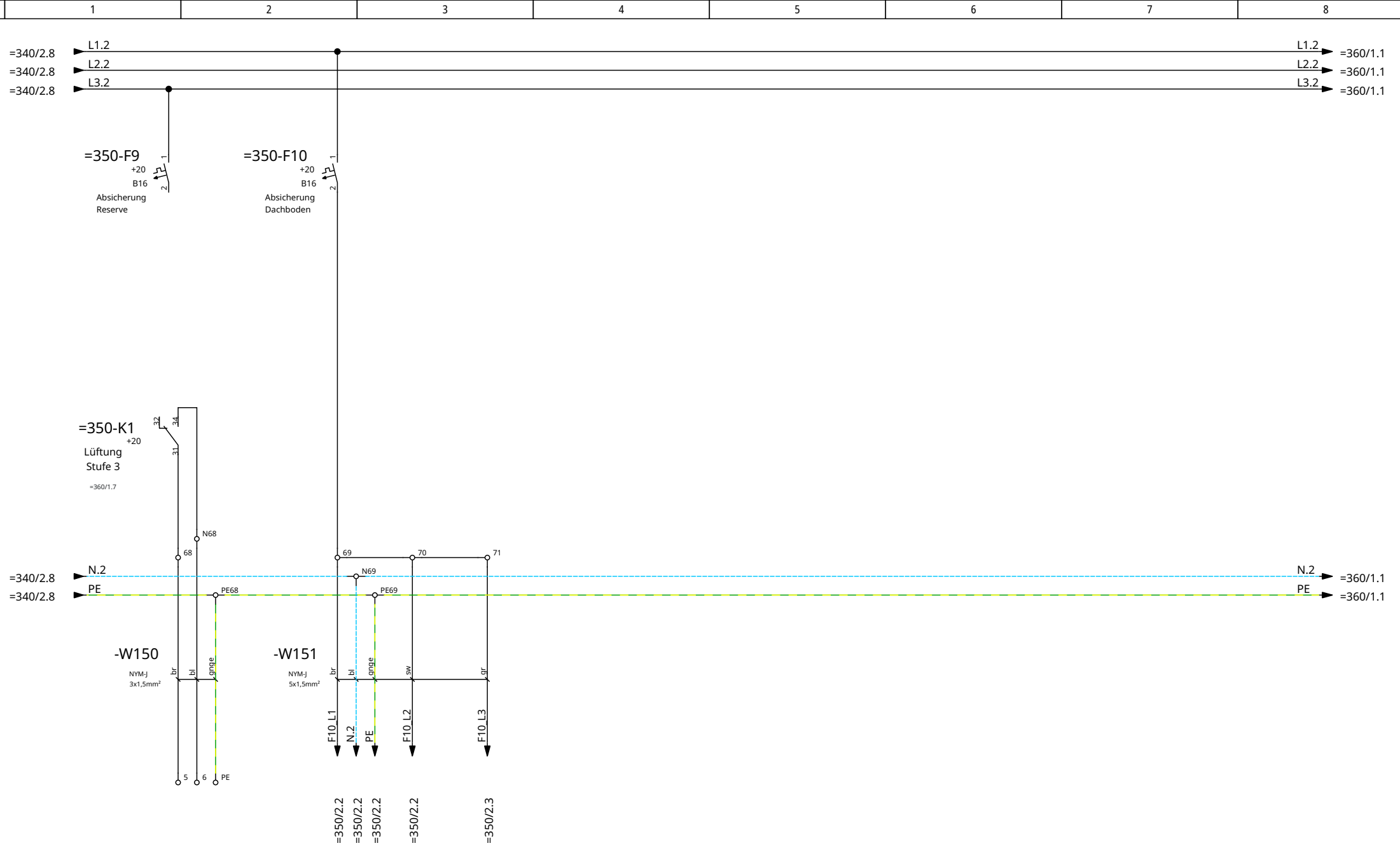

Klemmkasten Lüftungsanlage

Alle Leitungen ohne Querschnittsangabe sind 1,5mm²

c			Druck:	27/05/2020
b			Erstellt:	03/02/2018
a			Gez.	Wendelken
	MODIFICATION	Datum	Name	Gepr.
				T.Wendelken

E-Verteilung

Wendelken

Hausverteilung	.-1	=350	1
Dachboden	2006	EIB	Blatt : 48 48



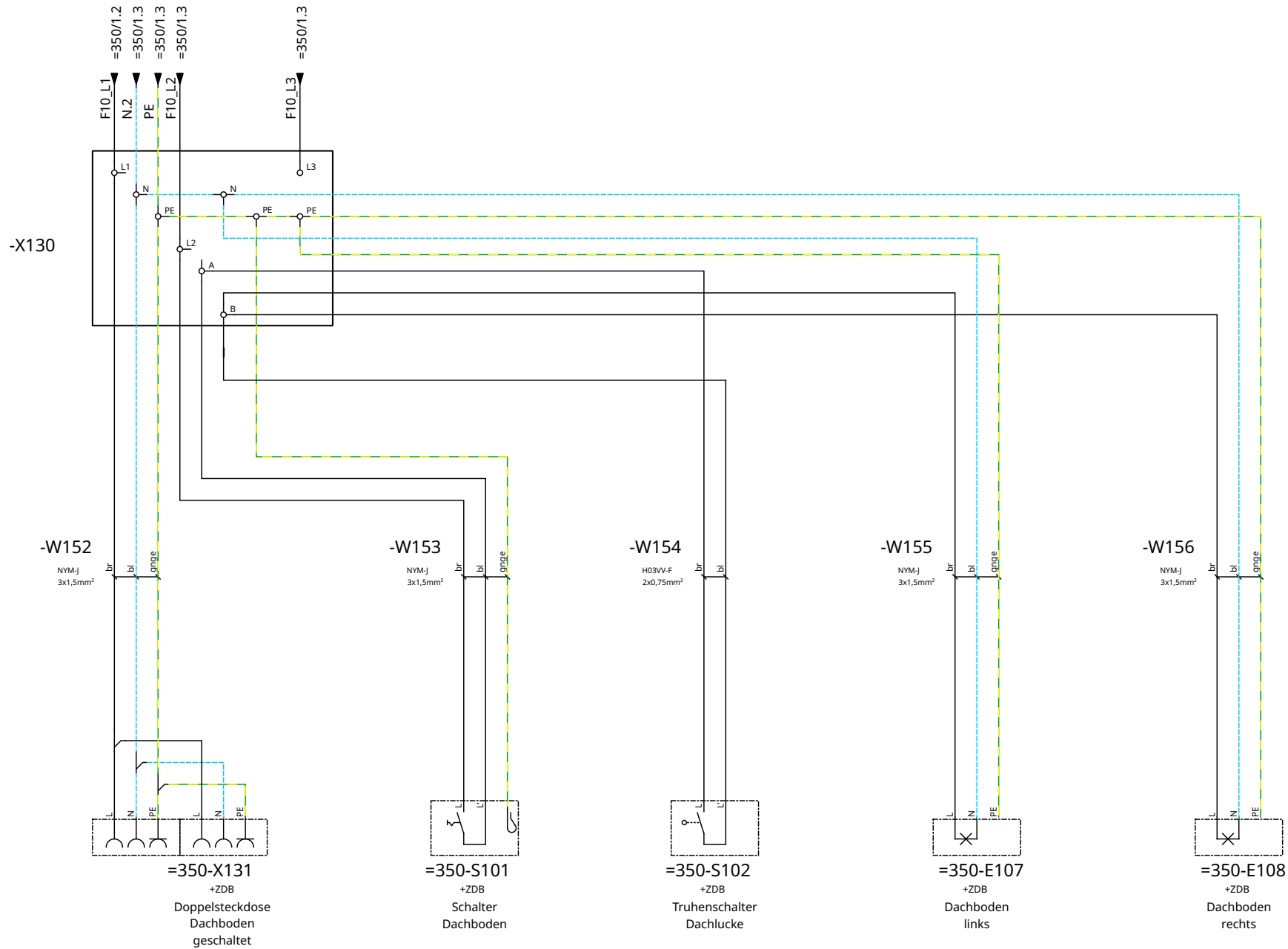

Alle Leitungen ohne Querschnittsangabe sind 1,5mm<sup>2</sup>

c			Druck:	27/05/2020
b			Erstellt:	28/09/2018
a			Gez.	Wendelken
	MODIFICATION	Datum	Name	Gepr.
				T.Wendelken

E-Verteilung



Wendelken

Hausverteilung			.-1	=350	2
Dachboden	2006	EIB	Blatt : 49		49

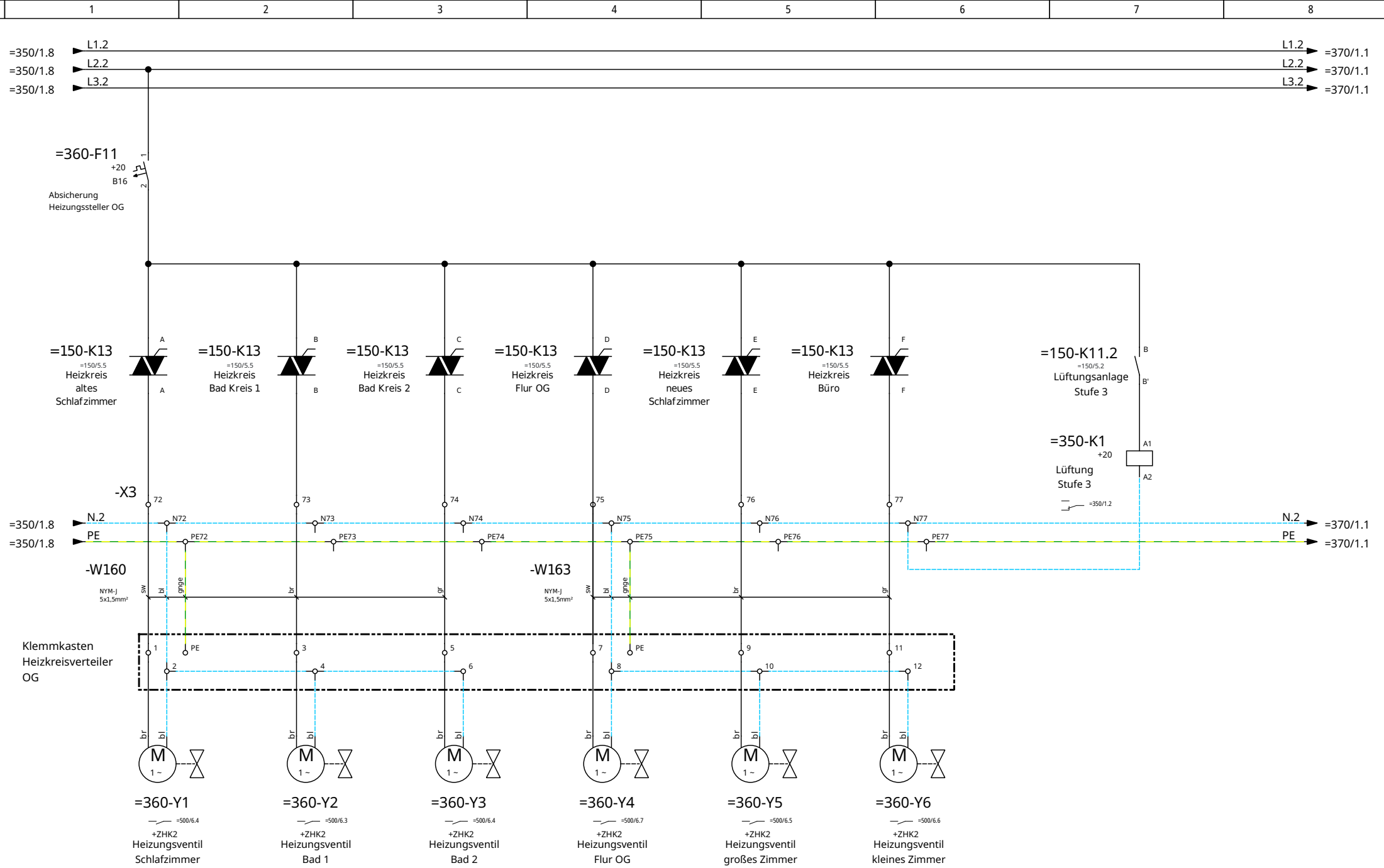

Alle Leitungen ohne Querschnittsangebe sind 1,5mm²

c			Druck:	27/05/2020
b			Erstellt:	23/01/2017
a			Gez.	Wendelken
	MODIFICATION	Datum	Name	Gepr.
				T.Wendelken

E-Verteilung

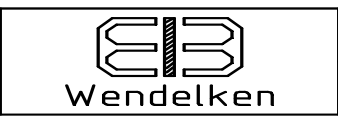

Hausverteilung  
Heizkreisverteiler OG

2006

.-1  
EIB

=360  
Blatt : 50

1  
50

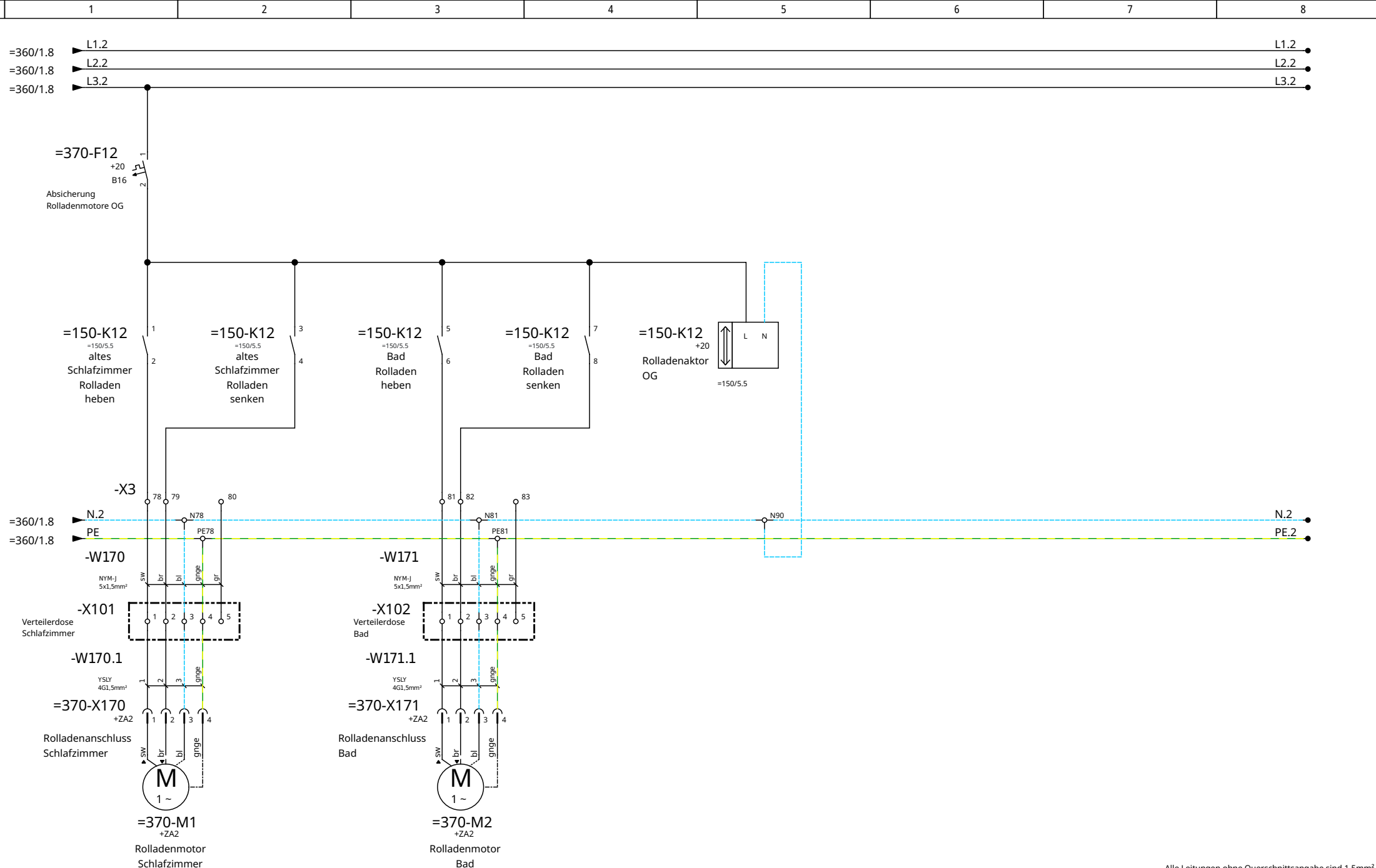

Alle Leitungen ohne Querschnittsangabe sind 1,5mm<sup>2</sup>

c			Druck:	27/05/2020
b			Erstellt:	25/01/2017
a			Gez.	Wendelken
	MODIFICATION	Datum	Name	Gepr.
				T.Wendelken

E-Verteilung

Wendelken

Hausverteilung	.-1	=370	1
Rolläden OG	2006	EIB	Blatt : 51
			51

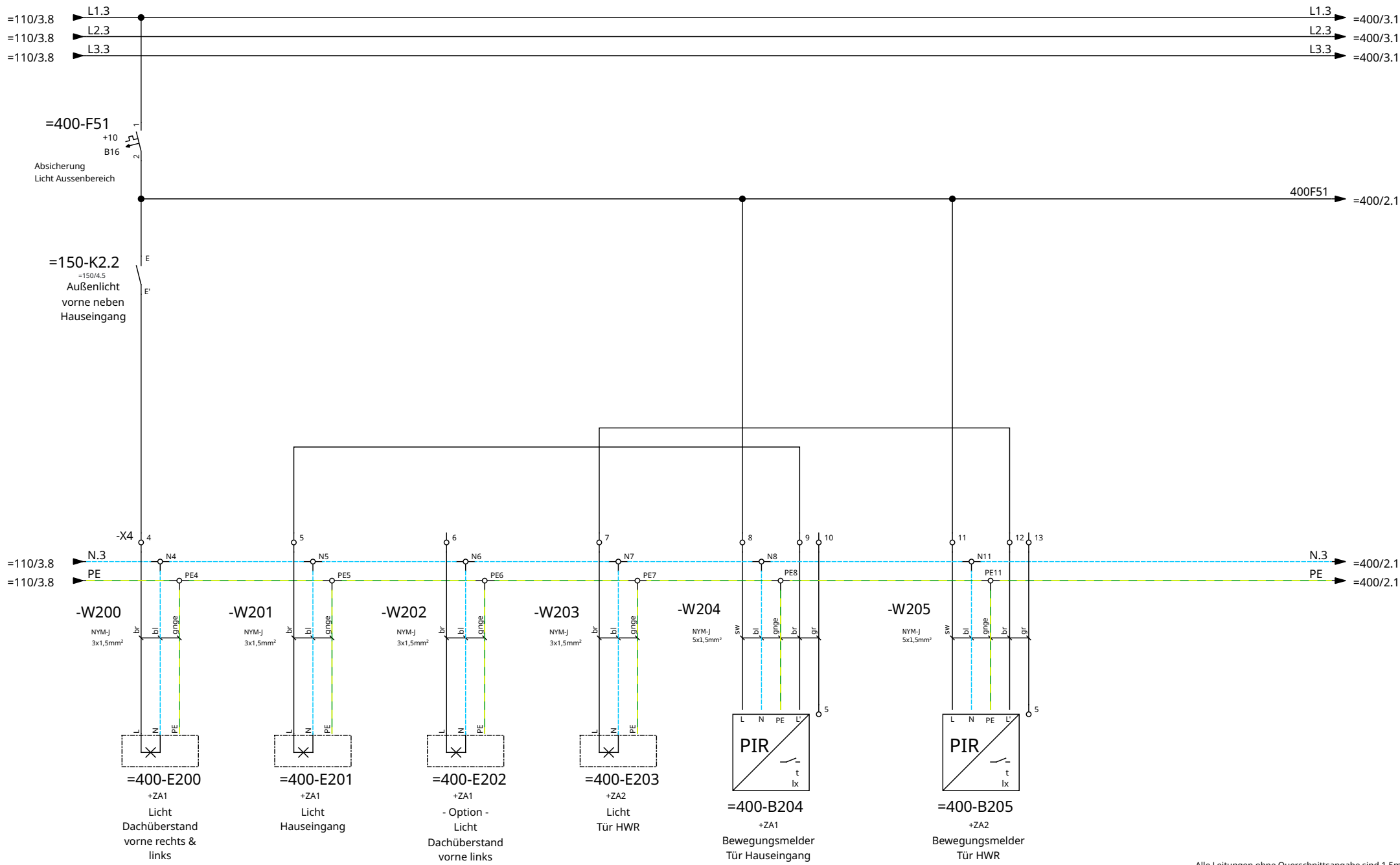

Alle Leitungen ohne Querschnittsangabe sind 1,5mm<sup>2</sup>

c				Druck:	27/05/2020
b				Erstellt:	24/04/2017
a				Gez.	Wendelken
	MODIFICATION	Datum	Name	Gepr.	T.Wendelken

E-Verteilung	 <b>Wendelken</b>	Hausverteilung	.-1	=400	1
		Beleuchtung draußen	2006	EIB	Blatt : 52

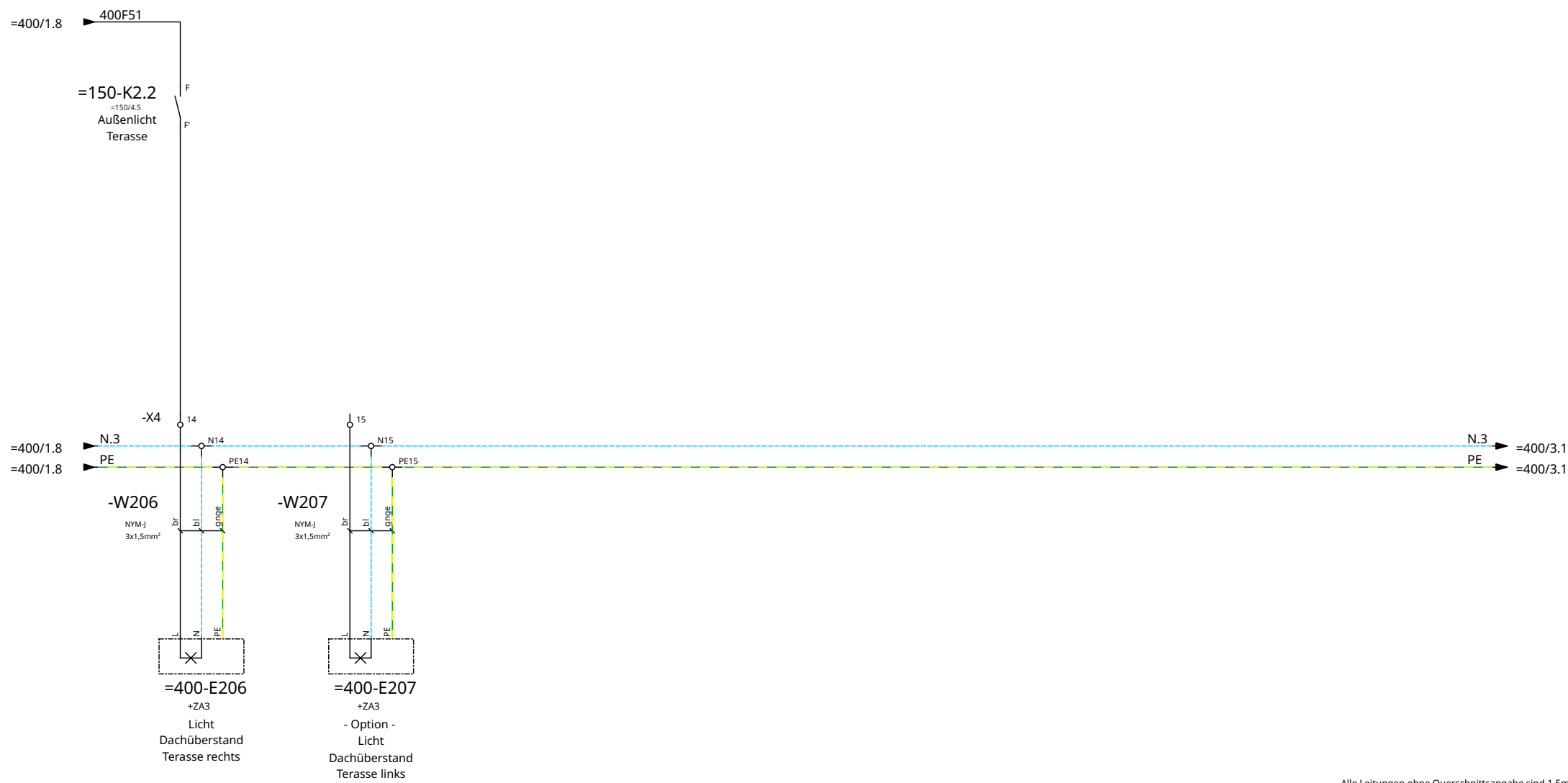

c				Druck:	27/05/2020
b				Erstellt:	25/04/2017
a				Gez.	Wendelken
	MODIFICATION	Datum	Name	Gepr.	T.Wendelken

E-Verteilung



Hausverteilung		.-1	=400	2
Beleuchtung draußen	2006	EIB	Blatt : 53	53

Alle Leitungen ohne Querschnittsangabe sind 1,5mm²

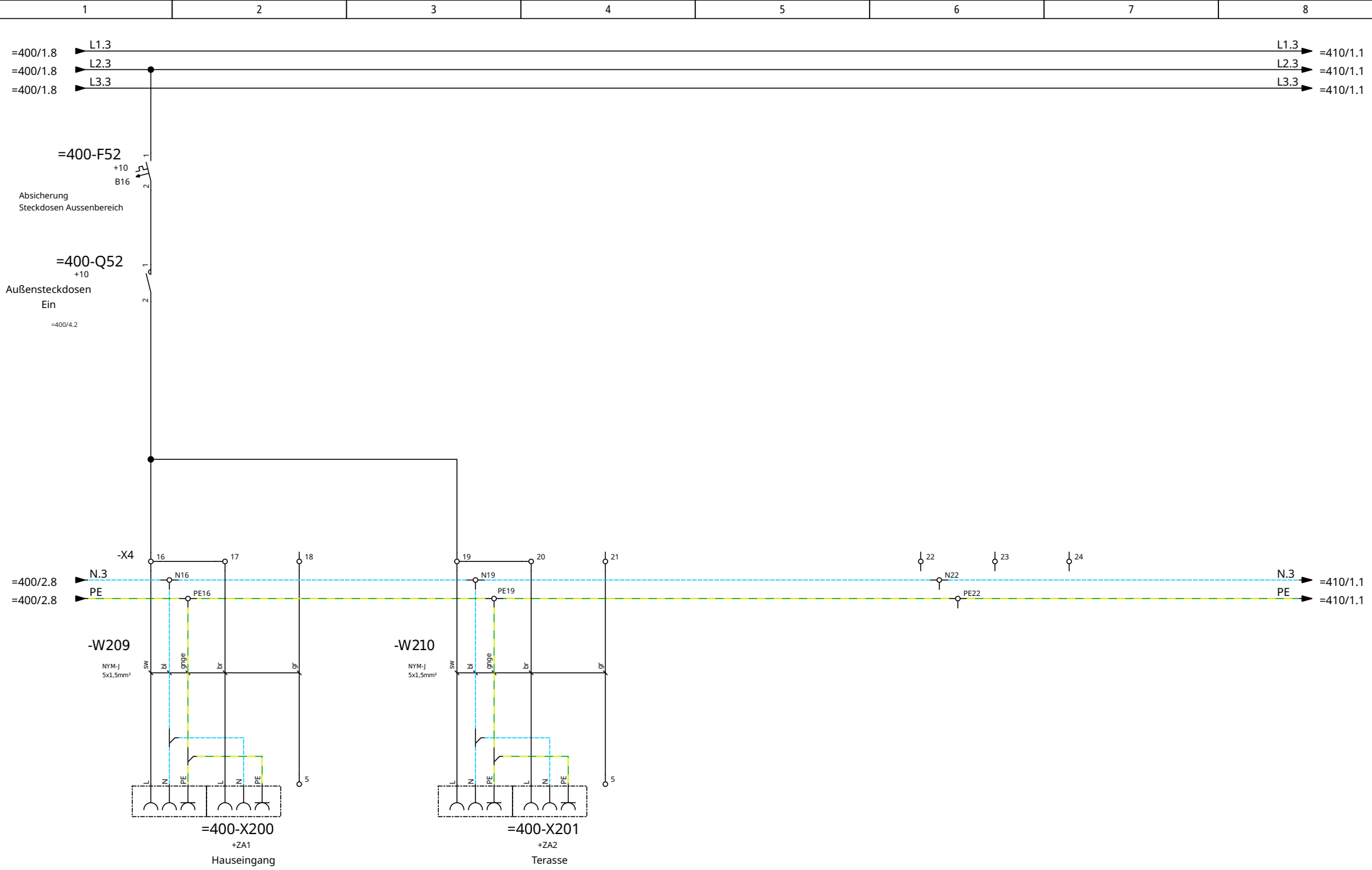

Alle Leitungen ohne Querschnittsangabe sind 1,5mm²

c			Druck:	27/05/2020
b			Erstellt:	25/04/2017
a			Gez.	Wendelken
	MODIFICATION	Datum	Gepr.	T.Wendelken

E-Verteilung



Hausverteilung  
Steckdosen draußen

2006

.-1  
EIB

=400  
Blatt : 54

3  
54



c				Druck:	27/05/2020
b				Erstellt:	19/02/2018
a				Gez.	Wendelken
	MODIFICATION	Datum	Name	Gepr.	T.Wendelken

E-Verteilung



Hausverteilung  
Steckdosen draußen

2006

.-1  
EIB

=400  
Blatt : 55

4  
55



Alle Leitungen ohne Querschnittsangabe sind 1,5mm<sup>2</sup>

c			Druck:	27/05/2020
b			Erstellt:	25/04/2017
a			Gez.	Wendelken
	MODIFICATION	Datum	Name	Gepr.
				T.Wendelken

E-Verteilung



Hausverteilung		.-1	=410	1
Option Garten	2006	EIB	Blatt : 56	56



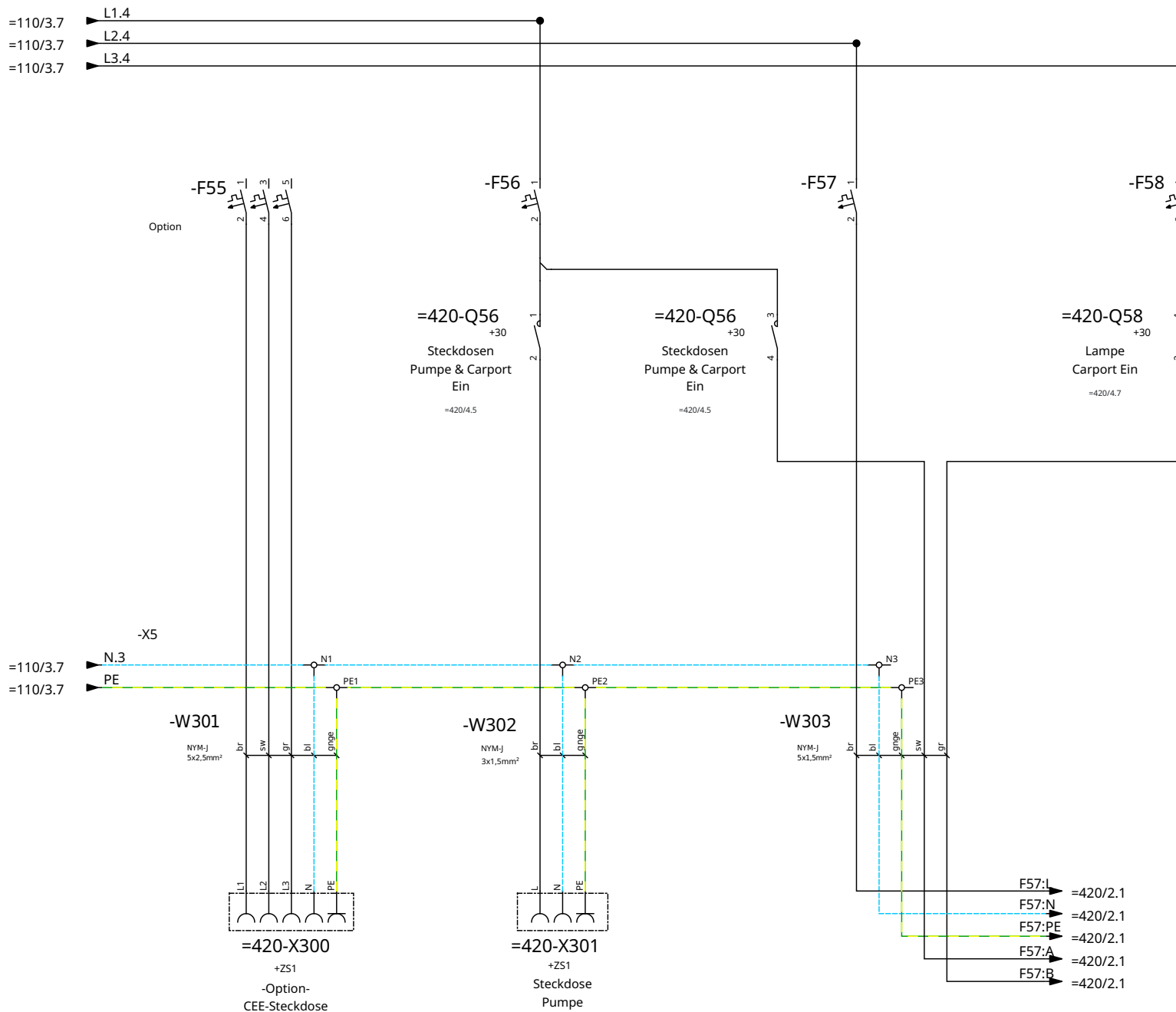

Alle Leitungen ohne Querschnittsangabe sind 1,5mm<sup>2</sup>

c				Druck:	27/05/2020
b				Erstellt:	26/04/2017
a				Gez.	Wendelken
	MODIFICATION	Datum	Name	Gepr.	T.Wendelken

E-Verteilung



Hausverteilung  
Schuppen

2006

.-1  
EIB

=420  
Blatt : 57  
57

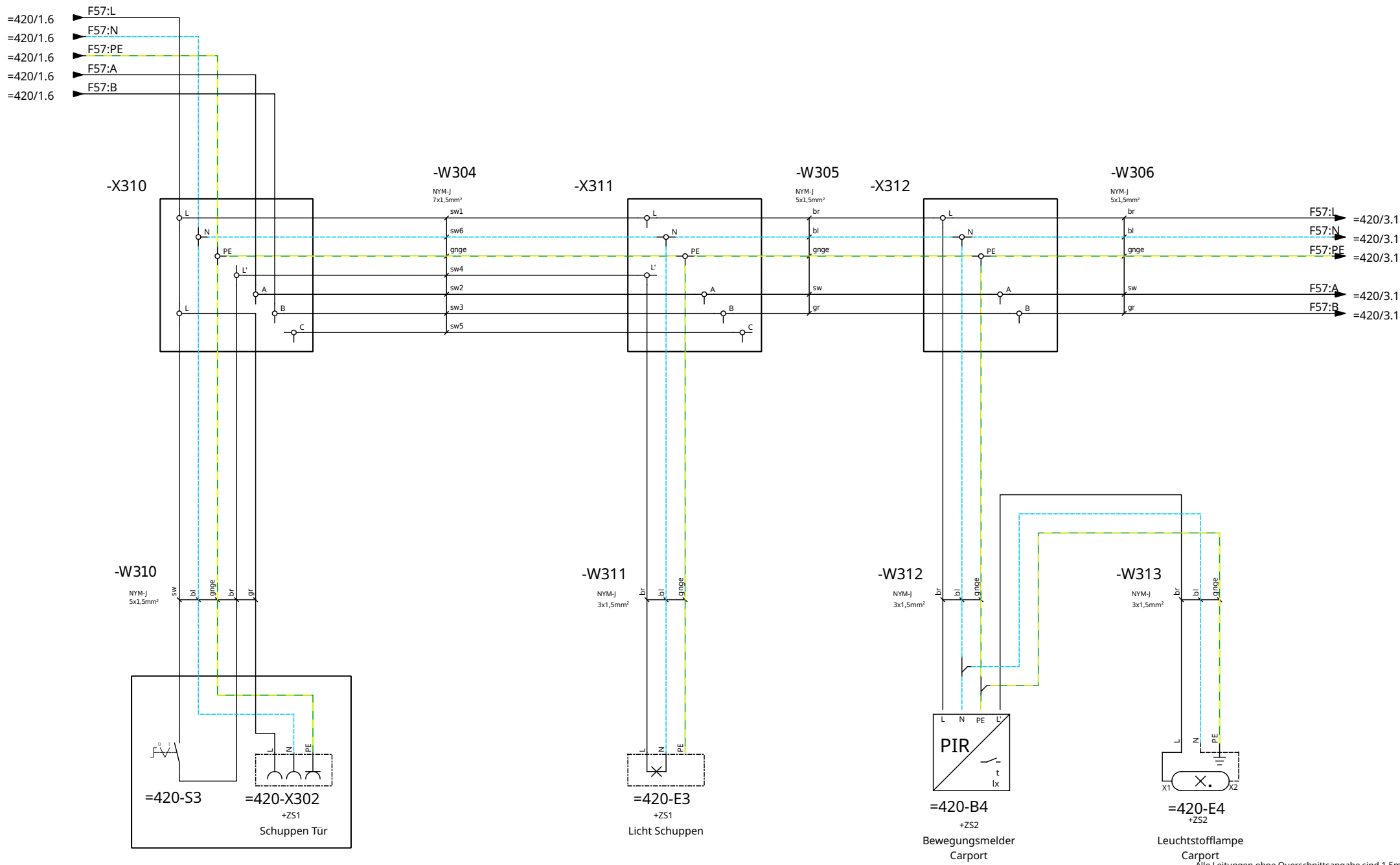

c			Druck:	27/05/2020
b			Erstellt:	28/04/2017
a			Gez.	Wendelken
	MODIFICATION	Datum	Name	Gepr.
				T.Wendelken

E-Verteilung



Hausverteilung  
Schuppen

2006

.-1  
EIB

=420  
Blatt : 58

2  
58

Alle Leitungen ohne Querschnittsangabe sind 1,5mm²

-X313

- =420/2.8 F57:L
- =420/2.8 F57:N
- =420/2.8 F57:PE
- =420/2.8 F57:A
- =420/2.8 F57:B

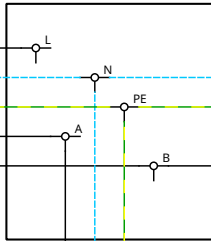

-W314

NYM-J  
3x1,5mm<sup>2</sup>



=420-X303

+ZS2

Doppelsteckdose  
Carport  
geschaltet

-W315

NYM-J  
3x1,5mm<sup>2</sup>



=420-E6

+ZS2

Lampe Carport  
(vorne)

Alle Leitungen ohne Querschnittsangabe sind 1,5mm<sup>2</sup>

c			Druck:	27/05/2020
b			Erstellt:	02/12/2017
a			Gez.	Wendelken
	MODIFICATION	Datum	Name	Gepr.
				T.Wendelken

E-Verteilung

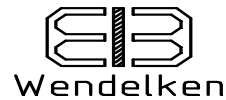

Hausverteilung

Schuppen

2006

.-1

EIB

=420

Blatt : 59

3

59

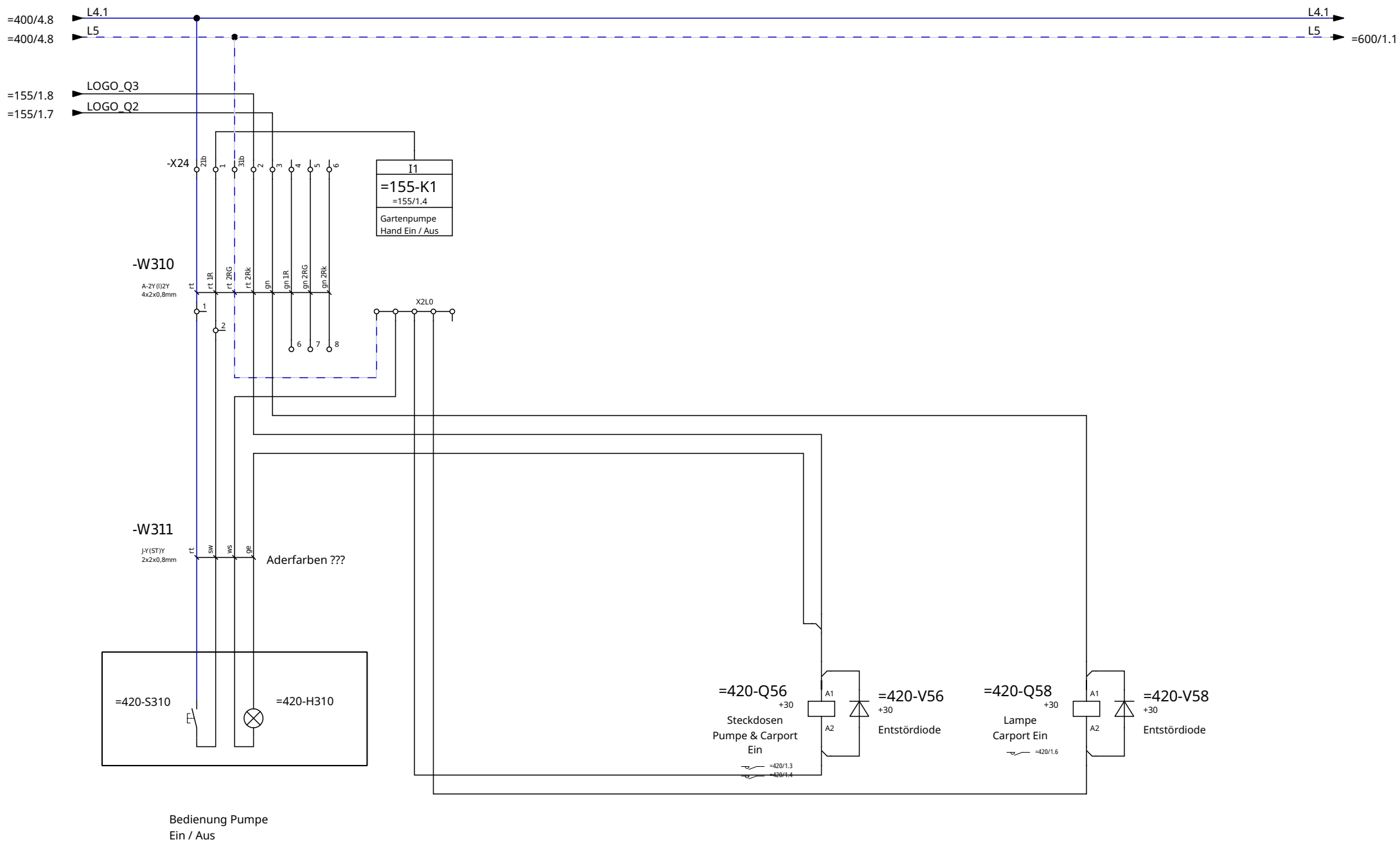

Bedienung Pumpe  
Ein / Aus

Alle Leitungen ohne Querschnittsangabe sind 1,5mm<sup>2</sup>

c			Druck:	27/05/2020
b			Erstellt:	28/04/2017
a			Gez.	Wendelken
	MODIFICATION	Datum	Name	Gepr.
				T.Wendelken

E-Verteilung	 Wendelken	Hausverteilung	.-1	=420	4
		Schuppen	2006	EIB	Blatt : 60

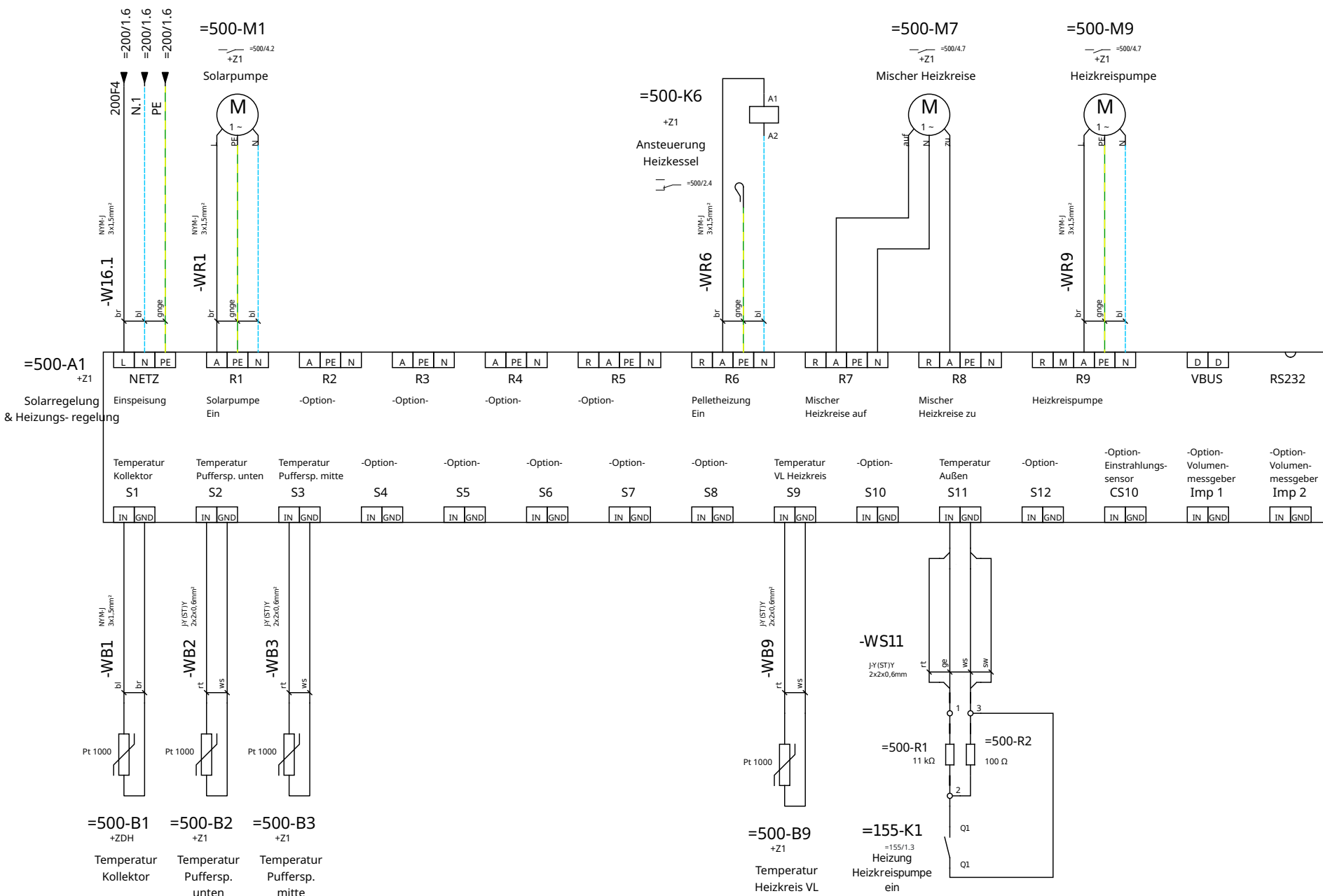

Alle Leitungen ohne Querschnittsangabe sind 1,5mm<sup>2</sup>

c			Druck:	27/05/2020
b			Erstellt:	31/12/2017
a			Gez.	Wendelken
	MODIFICATION	Datum	Name	Gepr.
				T.Wendelken

E-Verteilung

Wendelken

Hausverteilung	.-1	=500	1
Solarsteuerung	2006	EIB	Blatt : 61 61

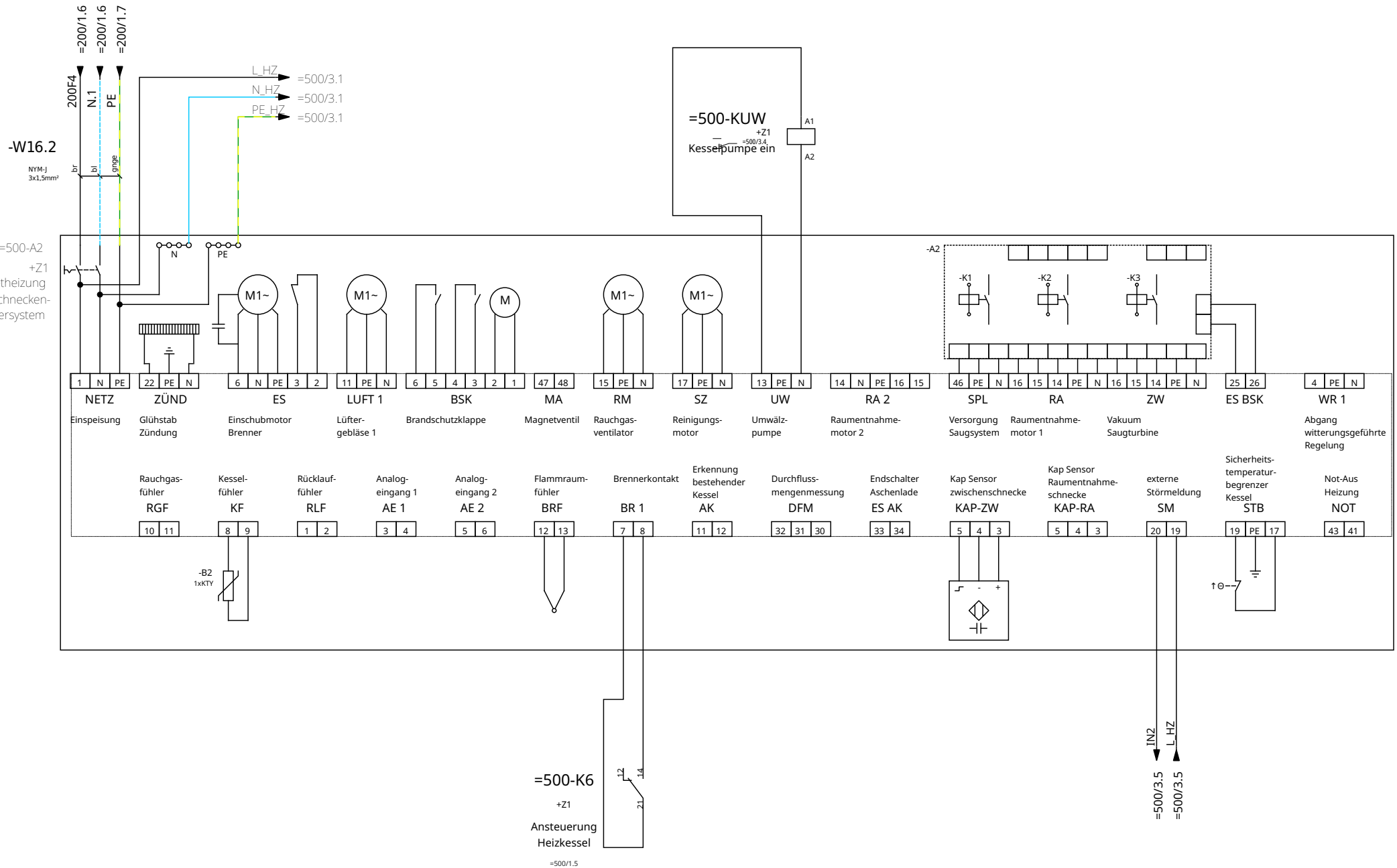

Alle Leitungen ohne Querschnittsangabe sind 1,5mm<sup>2</sup>

c			Druck:	27/05/2020
b			Erstellt:	30/12/2017
a			Gez.	Wendelken
	MODIFICATION	Datum	Name	Gepr.
				T.Wendelken

E-Verteilung		Hausverteilung		.-1	=500	2
		Heizungskesselsteuerung				

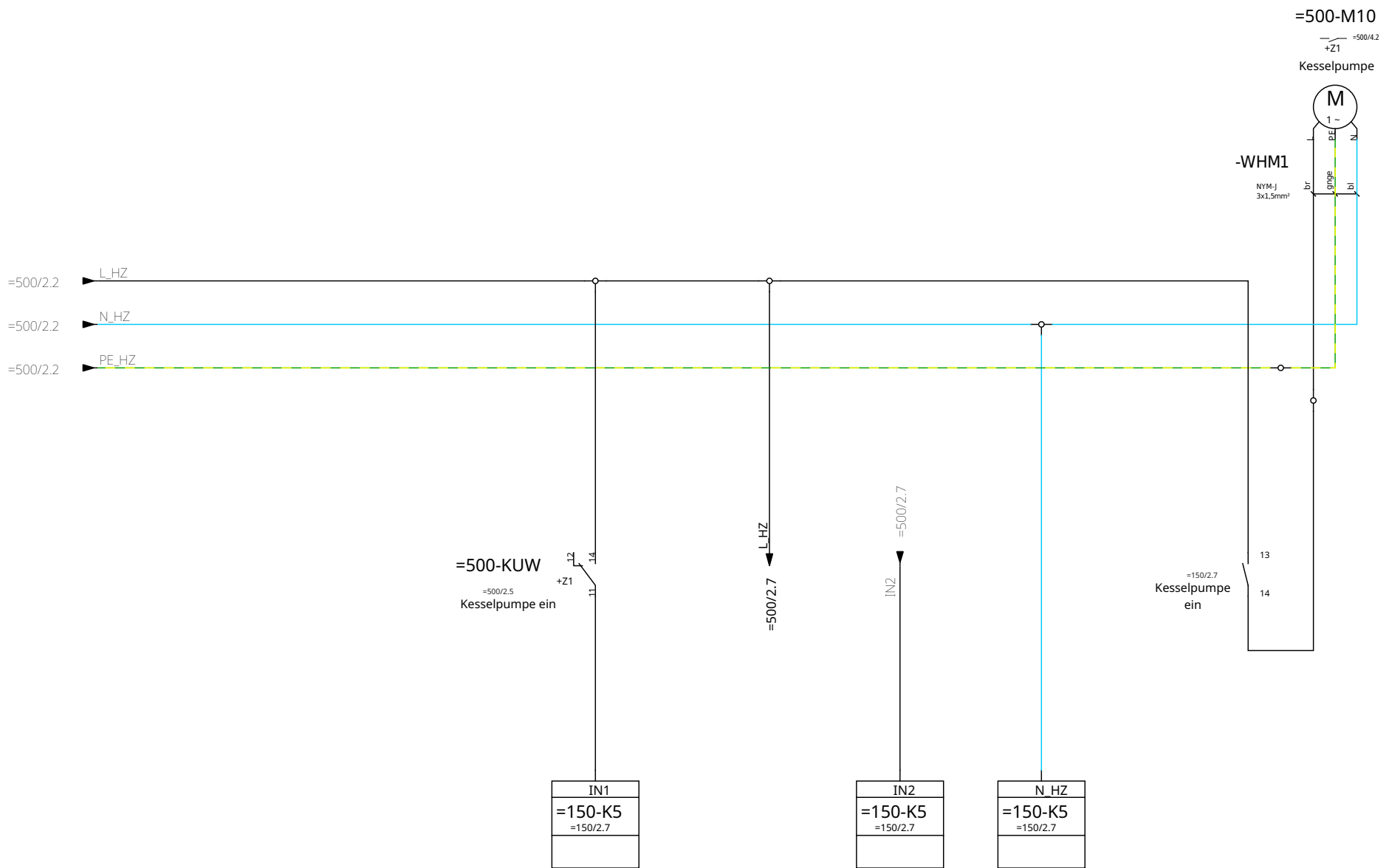

c				Druck:	27/05/2020
b				Erstellt:	30/04/2020
a				Gez.	Wendelken
	MODIFICATION	Datum	Name	Gepr.	T.Wendelken

E-Verteilung



Hausverteilung  
Heizungskesselsteuerung

2006  
EIB

.-1  
Blatt : 63

=500  
63

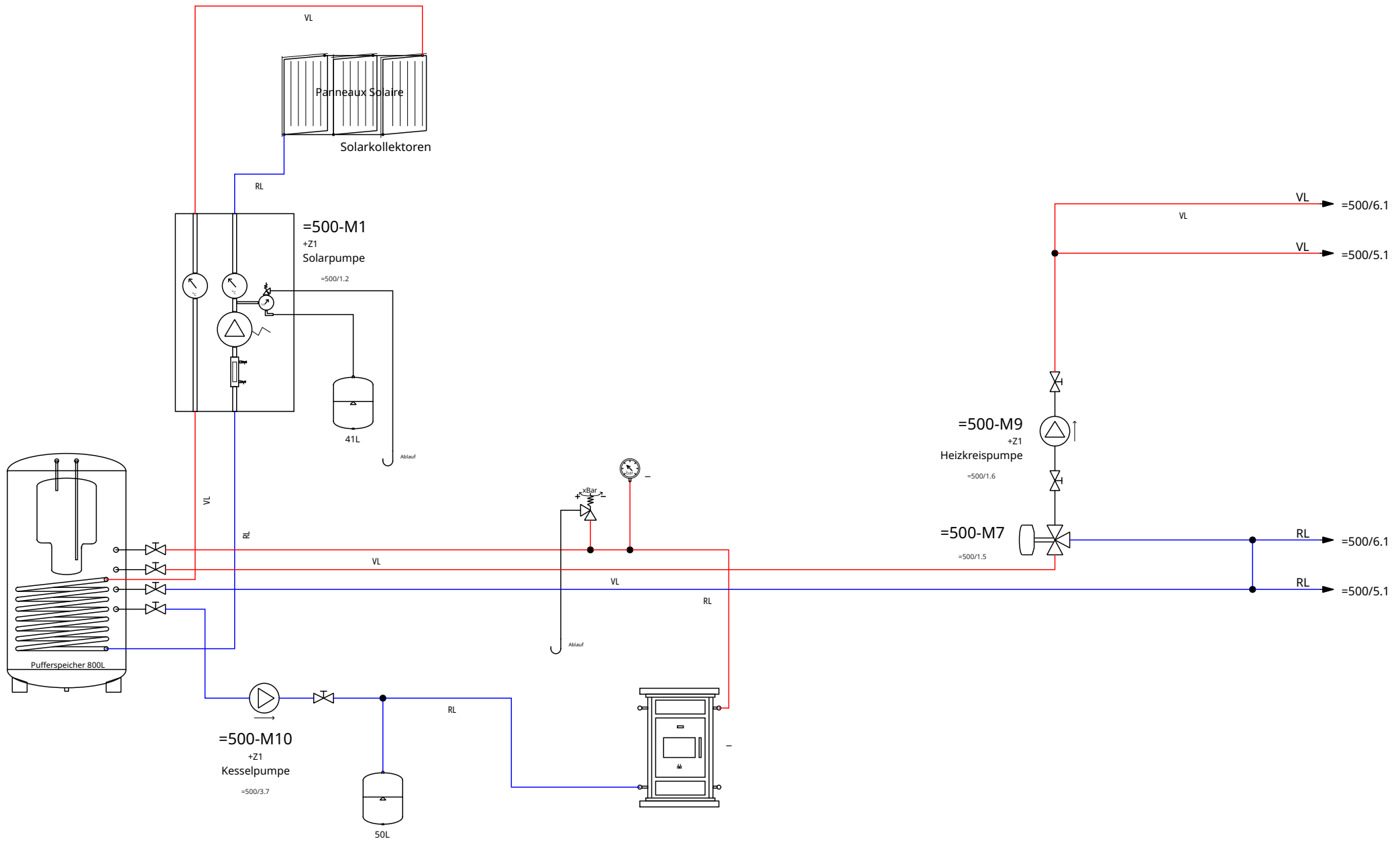

c				Druck:	27/05/2020
b				Erstellt:	10/03/2018
a				Gez.	Wendelken
	MODIFICATION	Datum	Name	Gepr.	T.Wendelken

E-Verteilung



Hausverteilung  
Heizung

2006

.-1  
EIB

=500  
Blatt : 64

4  
64



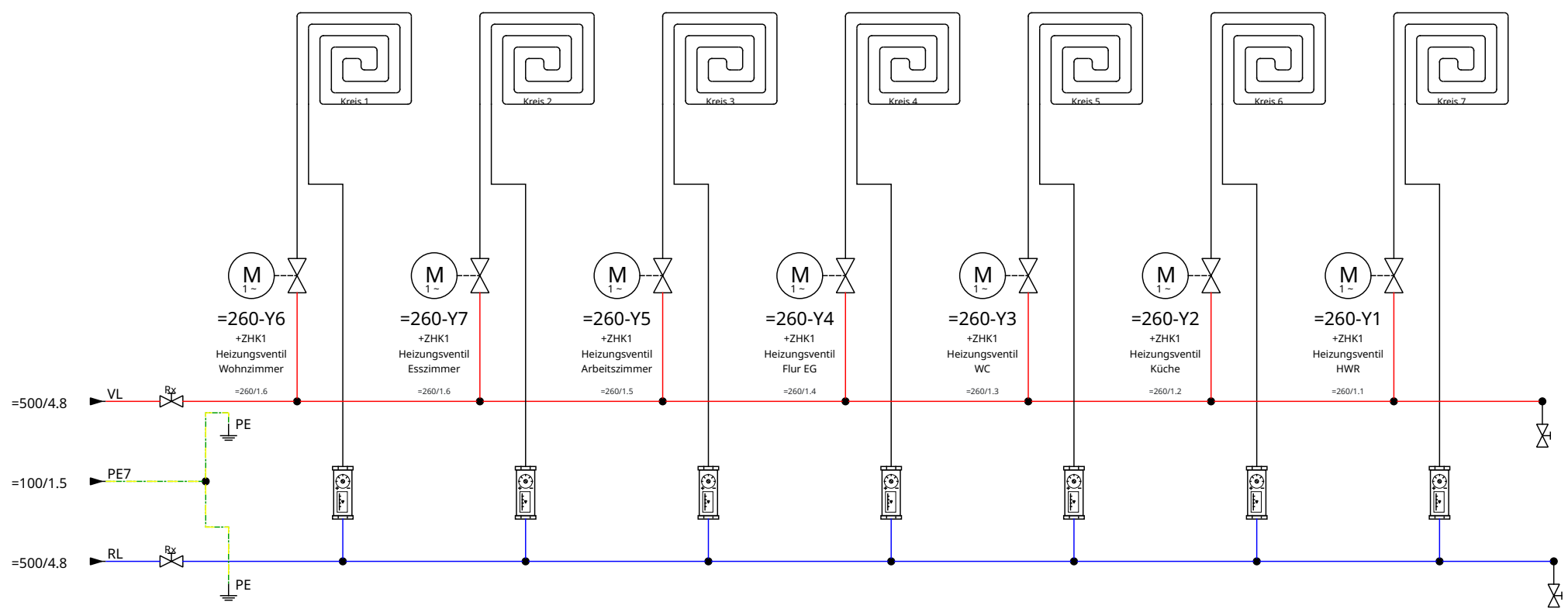

c				Druck:	27/05/2020
b				Erstellt:	02/11/2017
a				Gez.	Wendelken
	MODIFICATION	Datum	Name	Gepr.	T.Wendelken

E-Verteilung



Hausverteilung  
Heizkreisverteiler EG

2006

.-1  
EIB

=500  
Blatt : 65

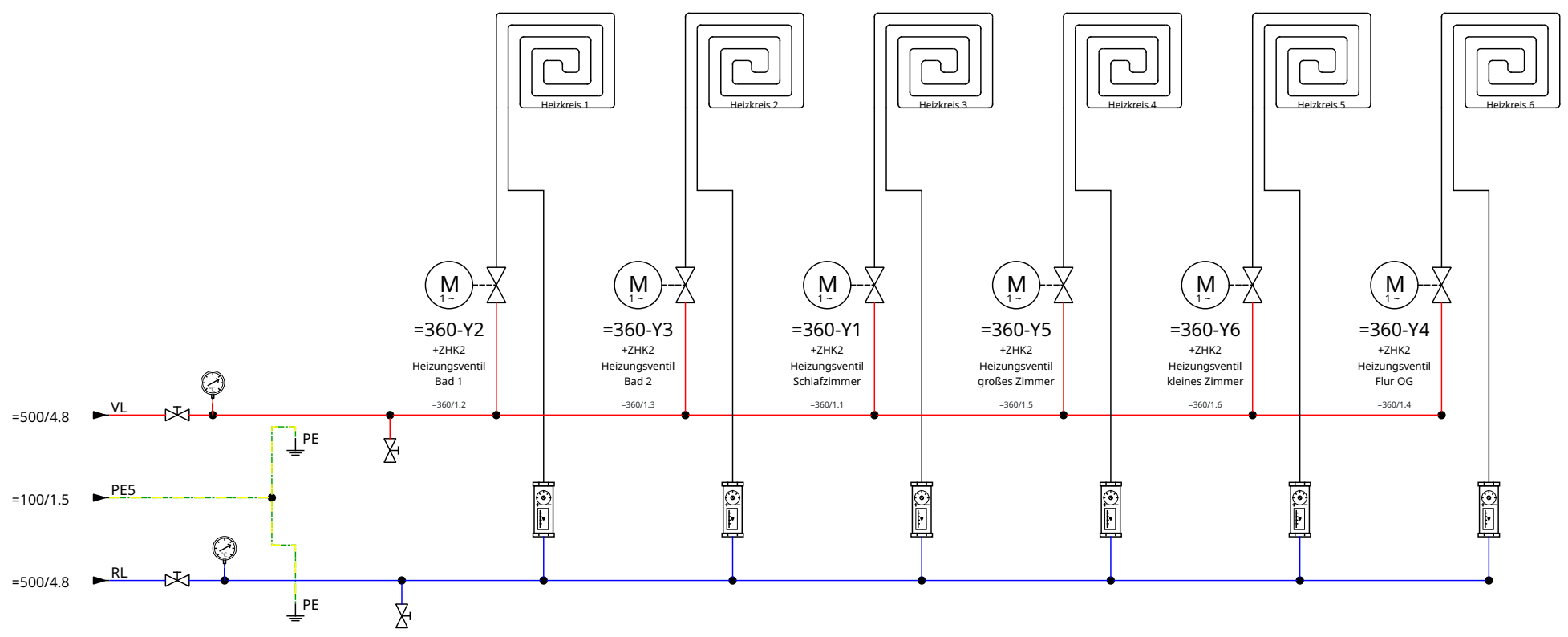

c			Druck:	27/05/2020
b			Erstellt:	10/03/2018
a			Gez.	Wendelken
	MODIFICATION	Datum	Gepr.	T.Wendelken

E-Verteilung

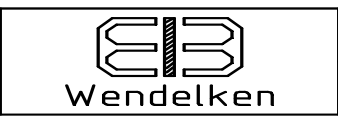

Hausverteilung  
Heizkreisverteiler OG

2006

.-1  
EIB

=500  
Blatt : 66

6  
66

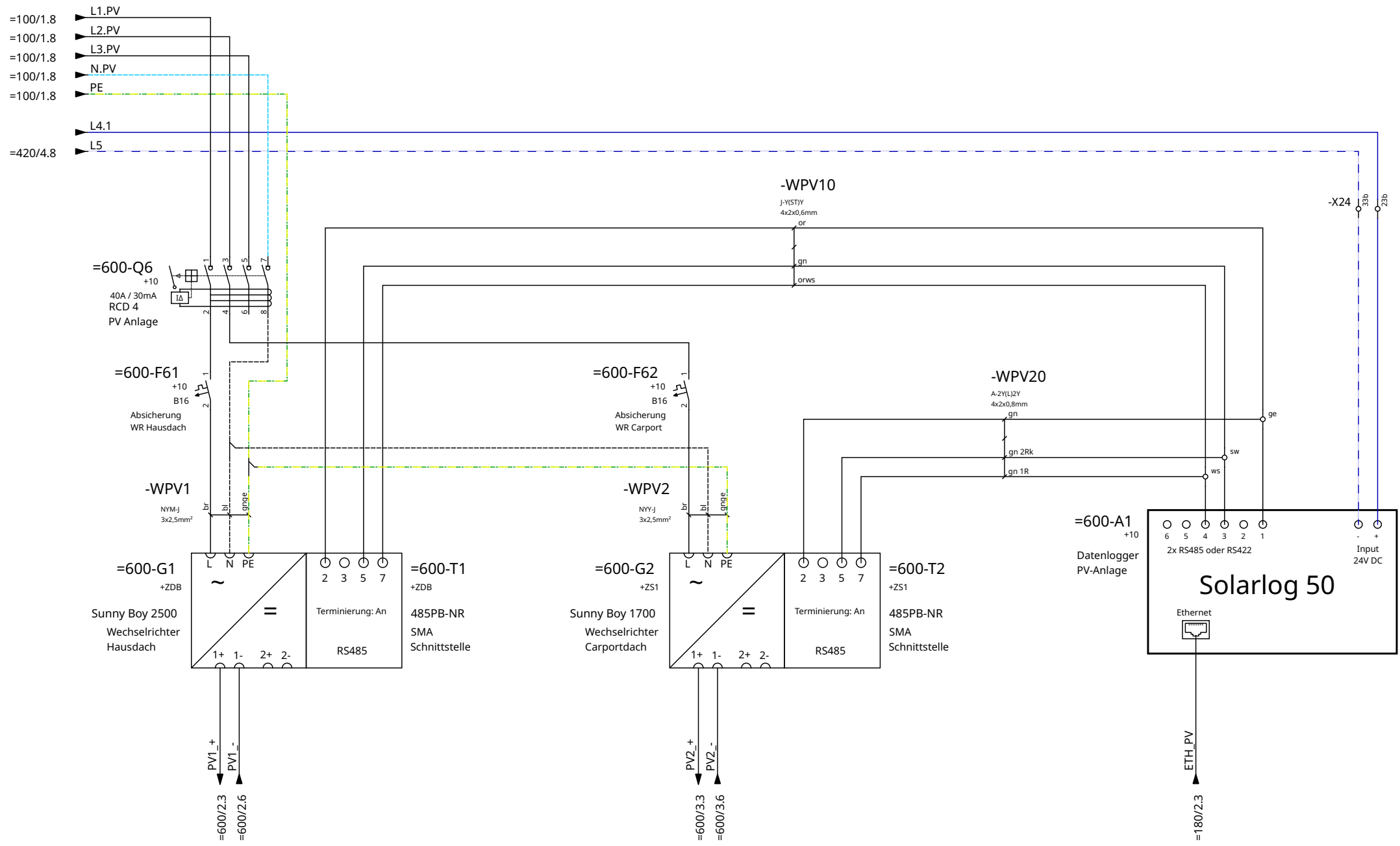

Alle Leitungen ohne Querschnittsangabe sind 1,5mm<sup>2</sup>

c			Druck:	27/05/2020
b			Erstellt:	03/02/2018
a			Gez.	Wendelken
	MODIFICATION	Datum	Name	Gepr.
				T.Wendelken

E-Verteilung	 <b>Wendelken</b>	Hausverteilung	.-1	=600	1
		PV-Anlage	2006	EIB	Blatt : 67

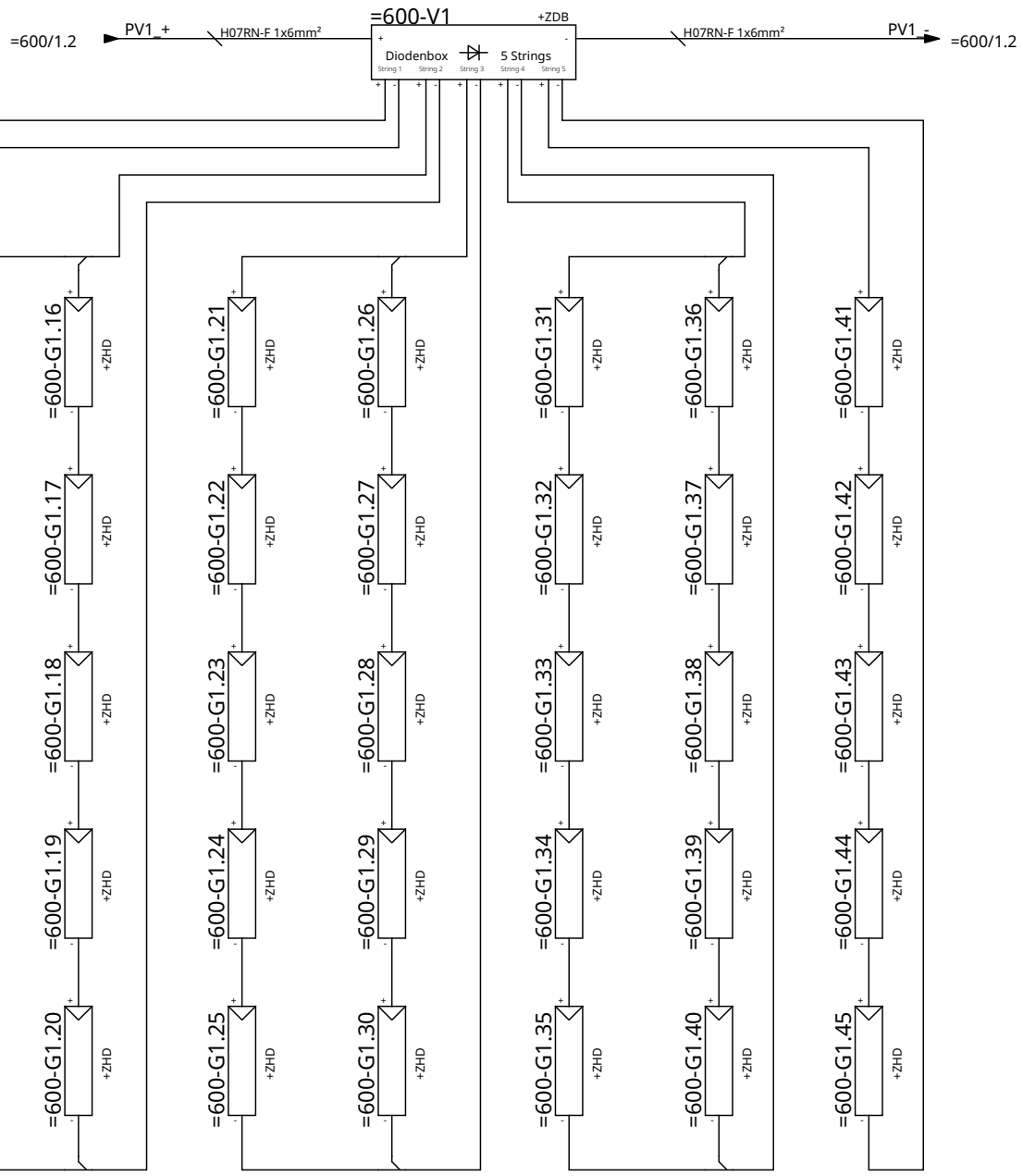

Alle Leitungen ohne Bezeichnung sind H07RN-F 1x4mm²

c			Druck:	27/05/2020
b			Erstellt:	15/10/2018
a			Gez.	Wendelken
	MODIFICATION	Datum	Name	Gepr.
				T.Wendelken

E-Verteilung



Wendelken

Hausverteilung	.-1	=600	2
PV-Anlage	2006	EIB	Blatt : 68
			68

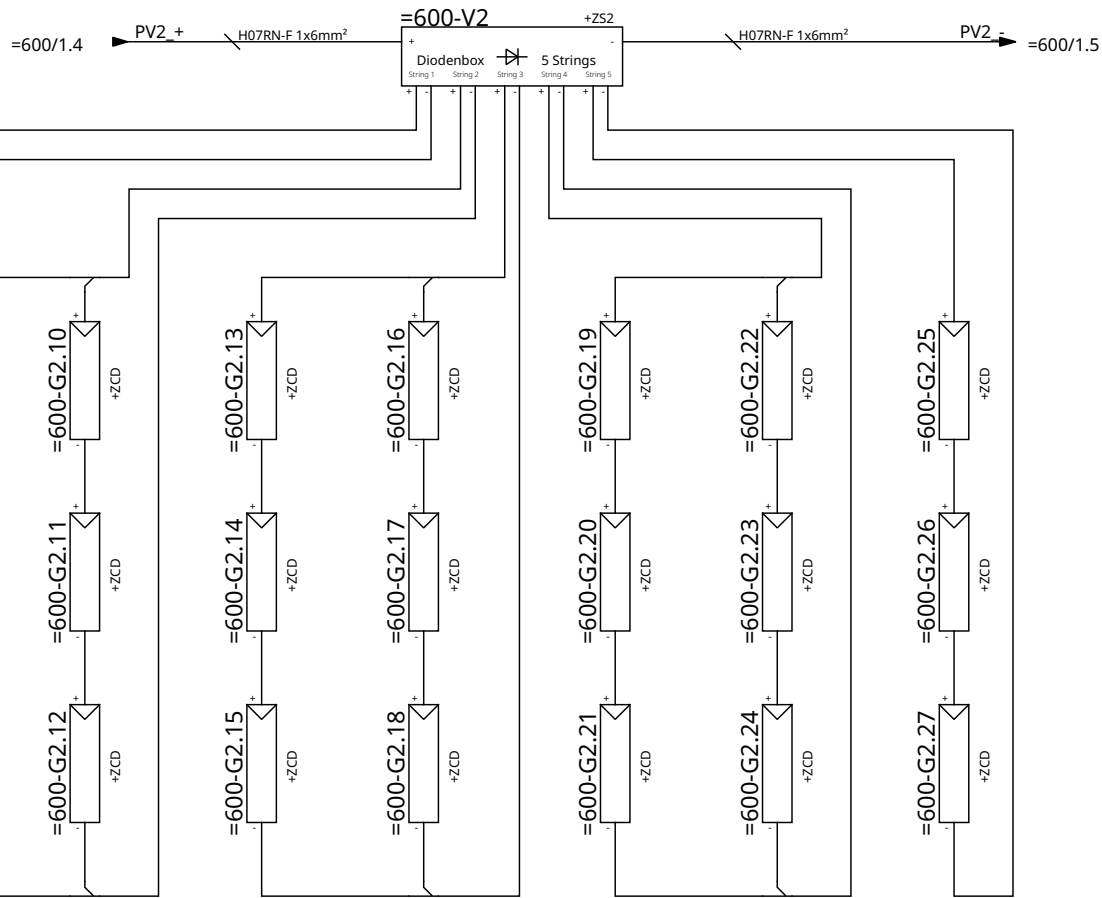

Alle Leitungen ohne Bezeichnung sind H07RN-F 1x4mm²

c			Druck:	27/05/2020
b			Erstellt:	17/10/2018
a			Gez.	Wendelken
	MODIFICATION	Datum	Name	Gepr.
				T.Wendelken

E-Verteilung



Hausverteilung  
PV-Anlage

2006

.-1  
EIB

=600  
Blatt : 69

3  
69



c				Druck:	27/05/2020	E-Verteilung	 Wendelken	Hausverteilung		.-1		70
b			Erstellt:									
a			Gez.	Wendelken								
	MODIFICATION	Datum	Name	Gepr.	T.Wendelken			2006	EIB	Blatt : 70	70	



c				Druck:	27/05/2020	E-Verteilung	 Wendelken	Hausverteilung		.-1		71	
b				Erstellt:									
a				Gez.	Wendelken								
	MODIFICATION	Datum	Name	Gepr.	T.Wendelken				2006	EIB	Blatt : 71	71	



c				Druck:	27/05/2020	E-Verteilung	 Wendelken	Hausverteilung		.-1		72	
b				Erstellt:									
a				Gez.	Wendelken								
	MODIFICATION	Datum	Name	Gepr.	T.Wendelken				2006	EIB	Blatt : 72	72	





c				Druck:	27/05/2020	E-Verteilung	 Wendelken	Hausverteilung		.-1		73
b			Erstellt:									
a			Gez.	Wendelken								
	MODIFICATION	Datum	Name	Gepr.	T.Wendelken			2006	EIB	Blatt : 73	73	



c				Druck:	27/05/2020	E-Verteilung	 Wendelken	Hausverteilung		.-1		74	
b				Erstellt:									
a				Gez.	Wendelken								
	MODIFICATION	Datum	Name	Gepr.	T.Wendelken				2006	EIB	Blatt : 74	74	



c				Druck:	27/05/2020	E-Verteilung	 Wendelken	Hausverteilung		.-1		75	
b				Erstellt:									
a				Gez.	Wendelken								
	MODIFICATION	Datum	Name	Gepr.	T.Wendelken				2006	EIB	Blatt : 75	75	



c				Druck:	27/05/2020	E-Verteilung	 Wendelken	Hausverteilung		.-1		76	
b				Erstellt:									
a				Gez.	Wendelken								
	MODIFICATION	Datum	Name	Gepr.	T.Wendelken				2006	EIB	Blatt : 76	76	



c				Druck:	27/05/2020	E-Verteilung	 Wendelken	Hausverteilung		.-1		77	
b				Erstellt:									
a				Gez.	Wendelken								
	MODIFICATION	Datum	Name	Gepr.	T.Wendelken				2006	EIB	Blatt : 77	77	



c				Druck:	27/05/2020	E-Verteilung	 Wendelken	Hausverteilung		.-1		78	
b				Erstellt:									
a				Gez.	Wendelken								
	MODIFICATION	Datum	Name	Gepr.	T.Wendelken				2006	EIB	Blatt : 78	78	



c				Druck:	27/05/2020	E-Verteilung	 Wendelken	Hausverteilung		.-1		79	
b				Erstellt:									
a				Gez.	Wendelken								
	MODIFICATION	Datum	Name	Gepr.	T.Wendelken				2006	EIB	Blatt : 79	79	



c				Druck:	27/05/2020	E-Verteilung	 Wendelken	Hausverteilung		.-1		80	
b				Erstellt:									
a				Gez.	Wendelken								
	MODIFICATION	Datum	Name	Gepr.	T.Wendelken				2006	EIB	Blatt : 80	80	





c				Druck:	27/05/2020	E-Verteilung	 Wendelken	Hausverteilung		.-1		81	
b				Erstellt:									
a				Gez.	Wendelken								
	MODIFICATION	Datum	Name	Gepr.	T.Wendelken				2006	EIB	Blatt : 81	81	



c				Druck:	27/05/2020	E-Verteilung	 Wendelken	Hausverteilung		.-1		82	
b				Erstellt:									
a				Gez.	Wendelken								
	MODIFICATION	Datum	Name	Gepr.	T.Wendelken				2006	EIB	Blatt : 82	82	



c				Druck:	27/05/2020	E-Verteilung	 Wendelken	Hausverteilung		.-1		83	
b				Erstellt:									
a				Gez.	Wendelken								
	MODIFICATION	Datum	Name	Gepr.	T.Wendelken				2006	EIB	Blatt : 83	83	



c				Druck:	27/05/2020	E-Verteilung	 Wendelken	Hausverteilung		.-1		84
b			Erstellt:									
a			Gez.	Wendelken								
	MODIFICATION	Datum	Name	Gepr.	T.Wendelken			2006	EIB	Blatt : 84		84



c				Druck:	27/05/2020	E-Verteilung	 Wendelken	Hausverteilung		.-1		85	
b				Erstellt:									
a				Gez.	Wendelken								
	MODIFICATION	Datum	Name	Gepr.	T.Wendelken				2006	EIB	Blatt : 85	85	



c				Druck:	27/05/2020	E-Verteilung	 Wendelken	Hausverteilung		.-1		86	
b				Erstellt:									
a				Gez.	Wendelken								
	MODIFICATION	Datum	Name	Gepr.	T.Wendelken				2006	EIB	Blatt : 86	86	



c				Druck:	27/05/2020	E-Verteilung	 Wendelken	Hausverteilung		.-1		87	
b				Erstellt:									
a				Gez.	Wendelken								
	MODIFICATION	Datum	Name	Gepr.	T.Wendelken				2006	EIB	Blatt : 87	87	



c				Druck:	27/05/2020	E-Verteilung	 Wendelken	Hausverteilung		.-1		88	
b				Erstellt:									
a				Gez.	Wendelken								
	MODIFICATION	Datum	Name	Gepr.	T.Wendelken				2006	EIB	Blatt : 88	88	





c				Druck:	27/05/2020	E-Verteilung	 Wendelken	Hausverteilung		.-1		89	
b				Erstellt:									
a				Gez.	Wendelken								
	MODIFICATION	Datum	Name	Gepr.	T.Wendelken				2006	EIB	Blatt : 89	89	



c				Druck:	27/05/2020	E-Verteilung	 Wendelken	Hausverteilung		.-1		90	
b				Erstellt:									
a				Gez.	Wendelken								
	MODIFICATION	Datum	Name	Gepr.	T.Wendelken				2006	EIB	Blatt : 90	90	



c				Druck:	27/05/2020	E-Verteilung	 Wendelken	Hausverteilung		.-1		91
b			Erstellt:									
a			Gez.	Wendelken								
	MODIFICATION	Datum	Name	Gepr.	T.Wendelken			2006	EIB	Blatt : 91		91



c				Druck:	27/05/2020	E-Verteilung	 Wendelken	Hausverteilung		.-1		92	
b				Erstellt:									
a				Gez.	Wendelken								
	MODIFICATION	Datum	Name	Gepr.	T.Wendelken				2006	EIB	Blatt : 92	92	



c				Druck:	27/05/2020	E-Verteilung	 Wendelken	Hausverteilung		.-1		93	
b				Erstellt:									
a				Gez.	Wendelken								
	MODIFICATION	Datum	Name	Gepr.	T.Wendelken				2006	EIB	Blatt : 93	93	



c				Druck:	27/05/2020	E-Verteilung	 Wendelken	Hausverteilung		.-1		94	
b				Erstellt:									
a				Gez.	Wendelken								
	MODIFICATION	Datum	Name	Gepr.	T.Wendelken				2006	EIB	Blatt : 94	94	



c				Druck:	27/05/2020	E-Verteilung	 Wendelken	Hausverteilung		.-1		95
b			Erstellt:									
a			Gez.	Wendelken								
	MODIFICATION	Datum	Name	Gepr.	T.Wendelken			2006	EIB	Blatt : 95	95	



c				Druck:	27/05/2020	E-Verteilung	 Wendelken	Hausverteilung		.-1		96	
b				Erstellt:									
a				Gez.	Wendelken								
	MODIFICATION	Datum	Name	Gepr.	T.Wendelken				2006	EIB	Blatt : 96	96	





c				Druck:	27/05/2020	E-Verteilung	 Wendelken	Hausverteilung		.-1		97	
b				Erstellt:									
a				Gez.	Wendelken								
	MODIFICATION	Datum	Name	Gepr.	T.Wendelken				2006	EIB	Blatt : 97	97	



c				Druck:	27/05/2020	E-Verteilung	 Wendelken	Hausverteilung		.-1		98
b			Erstellt:									
a			Gez.	Wendelken								
	MODIFICATION	Datum	Name	Gepr.	T.Wendelken			2006	EIB	Blatt : 98	98	



c				Druck:	27/05/2020	E-Verteilung	 Wendelken	Hausverteilung		.-1		99	
b				Erstellt:									
a				Gez.	Wendelken								
	MODIFICATION	Datum	Name	Gepr.	T.Wendelken				2006	EIB	Blatt : 99	99	



c				Druck:	27/05/2020	E-Verteilung	 Wendelken	Hausverteilung		.-1		100
b				Erstellt:								
a				Gez.	Wendelken							
	MODIFICATION	Datum	Name	Gepr.	T.Wendelken			2006	EIB	Blatt : 100	100	